



FPi 6100/7100/8100 Series

Inserting System

Operator Guide



FCC Compliance

This equipment has been tested and found to comply with the limits for a Class A digital device, pursuant to part 15 of the FCC rules. These limits are designed to provide reasonable protection against interference when the equipment is operated in a commercial environment. This equipment generates, uses, and can radiate radio frequency energy and, if not installed and used in accordance with the instruction manual, may cause interference to radio communications. Operation of this equipment in a residential area is likely to cause interference, in which case the user will be required to correct the interference at his own expense.

CAUTION: Changes or modifications to this equipment not expressly approved by the party responsible for compliance (Pitney Bowes) could void the user's authority to operate the equipment.

Canada EMC Compliance

This class A digital apparatus complies with Canadian ICES-003.

Cet appareil numérique de la classe A est conforme à la norme NMB-003 du Canada.



It is certified that this system complies with all applicable Directives of the European Union.

Francotyp-Postalia GmbH
Prenzlauer Promenade 28 · 13089 Berlin (Germany)
Freecall: +49 800 372 62 68
info@francotyp.com · fp-francotyp.com

All rights reserved. This book may not be reproduced in whole or in part in any fashion or stored in a retrieval system of any type or transmitted by any means, electronically or mechanically, without the express, written permission of Francotyp-Postalia.

We have made every reasonable effort to ensure the accuracy and usefulness of this manual; however, we cannot assume responsibility for errors or omissions or liability for the misuse or misapplication of our products.

Due to our continuing program of product improvement, equipment and material specifications as well as performance features are subject to change without notice.

P-FP63136_EN; Rev. 00

09/2022

©2022 Francotyp-Postalia GmbH

Safety Information.....	v
Warning Labels.....	vi
1. System Overview	1-1
FPi 5100 - 8100 Inserter Overview.....	1-3
Product Features	1-3
System Components	1-3
Main Modules	1-3
Additional Modules Available	1-3
Control Panel Identification.....	1-6
Screen Option Keys.....	1-7
Fixed Function Keys	1-7
Machine Action Keys	1-8
Change the Language Display	1-9
How the System Works	1-10
Transport Deck	1-10
Mail Piece Path.....	1-10
Pre-fold Accumulator	1-10
Folder.....	1-10
Post-fold Accumulator.....	1-11
Insertion Area.....	1-11
Folder Bypass Path	1-11
Moistener, Closer, Sealer.....	1-11
System Covers	1-12
Open the Covers.....	1-13
Close the Covers	1-13
Paper Release Knobs/Levers.....	1-14
Feeder Tower.....	1-15
Add-On Modules.....	1-16
High Capacity Sheet Feeder (HCSF)	1-16
Flats Sealer.....	1-17
Vertical Power Stacker.....	1-18
Horizontal Belt Stacker	1-18
Exit Transport.....	1-18
Optional Features	1-18
File Based Processing	1-18
Exit Options	1-18
Mail Machine Interface (MMI)	1-18
Access Rights	1-19
User Access Levels	1-19
Log In.....	1-20
Log Out.....	1-20

2.	Display Screen	2-1
	Display Screen Overview.....	2-3
	Header Area.....	2-4
	Footer Area	2-4
	Status Area	2-5
	Navigating Options	2-8
	Icons and Letters	2-9
	Envelope Icons	2-9
	Fold Icons	2-9
	Sheet Icons.....	2-10
	Insert Icons	2-11
	Feeder Assignment Icons	2-12
	Other Icons	2-12
3.	Run a Job	3-1
	Powering Up	3-3
	Home Screen.....	3-4
	Run a Job	3-5
	Select a Job	3-6
	Set Up Feeders and Load Material.....	3-7
	Additional Adjustments	3-20
	Pre-Run Adjustments.....	3-21
	Feed a Test Envelope	3-21
	Perform Width Adjustments (Outer Envelope Openers)	3-22
	Perform Length Adjustments (Inner Envelope Openers).....	3-23
	Verify Settings.....	3-24
	Manual Feeder.....	3-25
	Adjust Manual Lever for Stiff Media Mode (FPi 8100 Only).....	3-26
	Run a Trial Piece	3-27
	Review Job Settings	3-29
	Start the Job	3-30
	SwiftStart™ Jobs	3-30
	Running the Mail Machine Interface	3-31
	Adjust Screen Brightness and Contrast.....	3-33
	Set the Time and/or Date.....	3-34
	Refill the Sealing Solution.....	3-35
4.	Scanning	4-1
	Scanning Overview.....	4-3
	1D Scanning Overview (includes OMR)	4-3
	2D Data Matrix Scanning Overview.....	4-5
	Physical Specifications - 2D Data Matrix Barcodes	4-6
	Printing Specifications - 2D Data Matrix Barcodes	4-7

Clear Zone Requirements.....	4-10
Recommended Barcode Content	4-11
Adjusting the Scan Heads	4-12
Adjusting Scan Heads for Ladder or 2D Orientation Marks	4-12
Additional Information	4-17
5. Stoppages and Troubleshooting	5-1
Clear Material Stoppages	5-3
Clear a Stoppage	5-3
Resume the Job.....	5-3
Outsorted Material	5-4
Troubleshooting and Self-Help Aides	5-4
6. Maintenance	6-1
Routine Maintenance.....	6-3
Daily Tasks.....	6-3
Replace the Moistener Wick.....	6-3
Replace the Moistener Brushes.....	6-5
Replace the Envelope Edge Marker Roller.....	6-6
7. Specifications	7-1
System Specifications.....	7-3
System Footprint - Dimensions.....	7-3
Component Specifications	7-4
Component Dimensions	7-4
Component Capacities	7-4
Scanning Capability (optional)	7-6
Environmental Limits	7-6
Feeder Tower and Base Material Specifications.....	7-7
General Information	7-7
Outer Envelopes	7-7
Inserts	7-10
Sheets.....	7-11
High Capacity Sheet Feeder (HCSF) Material Specifications ..	7-12
General Information	7-12
Sheets.....	7-12
Materials Not Certified for Use.....	7-13



This page is intentionally blank.

Safety Information

Follow these precautions whenever you use your inserting system:

- Read all instructions before you attempt to operate the system.
- Use this equipment only for its intended purpose.
- Place the system close to an easily accessible wall outlet.
- Place the system in an accessible location to allow for proper venting of the equipment and to facilitate servicing.
- Use the AC power adapter included with this device. Third party adapters may damage the device.
- Plug the AC adapter directly into a properly grounded wall outlet located near the equipment and easily accessible. Failure to properly ground the machine can result in severe personal injury and/or fire.
- The AC adapter/power cord is the primary means to disconnect this device from the AC supply.
- DO NOT use a wall outlet controlled by a wall switch or one that is shared with other equipment.
- DO NOT use an adapter plug on the line cord or wall outlet.
- DO NOT remove the ground pin from the line cord.
- DO NOT route the AC adapter power cord over sharp edges or trap it between furniture. Make sure there is no strain on the power cord.
- If the unit becomes damaged, unplug it from the wall.
- Keep fingers, long hair, jewelry and loose clothing away from moving parts at all times.
- Avoid touching moving parts or materials while the machine is in use. Before clearing a jam, be sure machine mechanisms come to a complete stop.
- Remove jammed material gently and carefully.
- DO NOT remove covers. Covers enclose hazardous parts that should only be accessed by properly trained service personnel.
- DO NOT place lighted candles, cigarettes, cigars, etc., on the system.
- To prevent overheating, do not cover vent openings.
- Use only approved supplies.
- Improper storage and use of aerosol dusters or flammable aerosol dusters can cause an explosive-like condition that could result in personal injury and/or property damage.
- Never use aerosol dusters labeled flammable and always read instructions and safety precautions on the duster container label.
- Operation of this equipment without periodic maintenance will inhibit optimum operating performance and could cause the equipment to malfunction.
- Always follow specific occupational safety and health standards for your workplace.
- To reduce the risk of fire or electrical shock, DO NOT attempt to remove covers or disassemble the control panel or its base. There are hazardous parts in this cabinet.
- Before operating the main inserting machine with this device, make sure the machine has been properly prepared and that any other personnel in the area are standing clear of the inserter.
- Immediately report to service any damaged or non-functioning components that renders the unit unsafe.

- Contact your system supplier for the following:
 - Supplies
 - Material Safety Data Sheets
 - If you should damage the unit
 - Required maintenance service schedule

If Your Stacker has an AC Adapter:

- Use the AC power adapter included with this device. Third party adapters may damage the device
- To protect against electrical shock, plug the AC adapter power cord into a properly grounded wall outlet.
- DO NOT route the power cord for the AC adapter over sharp edges or trap it between it between pieces of furniture. Make sure there is no strain on the power cord.

IMPORTANT: Some of the inserter features and options covered in this content may not be available on your inserter.

Warning Labels

The following warning labels are on the system to alert you to potential injury that could occur with careless operating procedures.

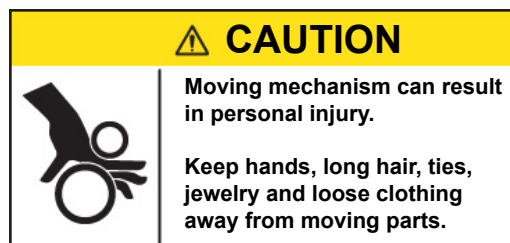

1. System Overview

Contents

FPI 5100 - 8100 Inserter Overview	1-3
Product Features	1-3
System Components	1-3
Main Modules	1-3
Additional Modules Available	1-3
Control Panel Identification.....	1-6
Screen Option Keys.....	1-7
Fixed Function Keys	1-7
Machine Action Keys	1-8
Change the Language Display	1-9
How the System Works	1-10
Transport Deck	1-10
Mail Piece Path.....	1-10
Pre-fold Accumulator	1-10
Folder	1-10
Post-fold Accumulator.....	1-11
Insertion Area	1-11
Folder Bypass Path	1-11
Moistener, Closer, Sealer	1-11
System Covers	1-12
Open the Covers	1-13
Close the Covers	1-13
Paper Release Knobs/Levers.....	1-14
Feeder Tower.....	1-15
Add-On Modules.....	1-16
High Capacity Sheet Feeder (HCSF)	1-16
Flats Sealer	1-17
Vertical Power Stacker	1-18
Horizontal Belt Stacker	1-18
Exit Transport	1-18
Optional Features	1-18
File Based Processing.....	1-18
Exit Options	1-18
Mail Machine Interface (MMI)	1-18
Access Rights.....	1-19
User Access Levels	1-19
Log In.....	1-20
Log Out.....	1-20



This page is intentionally blank.

FPI 5100 - 8100 Inserter Overview

FPI 5100 - 8100 are high throughput, mail creation systems designed to handle a broad range of applications with minimum operator setup adjustments. These systems have the ability to feed, fold, and insert mail piece components into an outer envelope. The systems generate letters or flats as the final mail piece. The systems also accept a variety of options that provide a wide range of capacities and operating speeds.

Product Features

- Folds up to a maximum of 10 sheets of 20 lb. (80 gsm) with a single fold
- Supports multiple inserts into flat envelopes
- Configurable with four flexible feeder trays, that come in two types:
 - Sheet trays - capable of feeding sheets
 - Insert trays - capable of feeding slip/insert materials, pre-folded inserts, thin booklets, and envelopes.
- The FPI 7100/8100 system is equipped with a High Capacity Envelope Feeder (HCEF) that allows for greater speed and throughput. The systems also accept material from optional upstream input devices.

System Components

Main Modules

These systems are configured with two major components:

- Feeder Tower
- Transport Deck
- Envelope Sealer

The feeder tower sends material from the feeder trays to the transport deck. Job parameters determine whether or not the material passes through the folder to the transport deck. If it does, numerous fold types are available, as is the ability to insert folded material into the mail piece collation.

The system can seal envelopes (letter only) before sending the final mail piece to a stacker unit.

Additional Modules Available

The base system configuration includes a feeder tower, transport deck, and envelope sealer. The FPI 7100/8100 features an additional integrated High Capacity Envelope Feeder.

Additional modules can be added to utilize the full potential of the system. The availability of these modules and options for your inserting system varies by region.

- High Capacity Sheet Feeder
- Flats Sealer
- Pre-folded Insert Feeder
- Vertical Power Stacker
- Horizontal Belt Stacker
- Exit Scanner

Component Identification

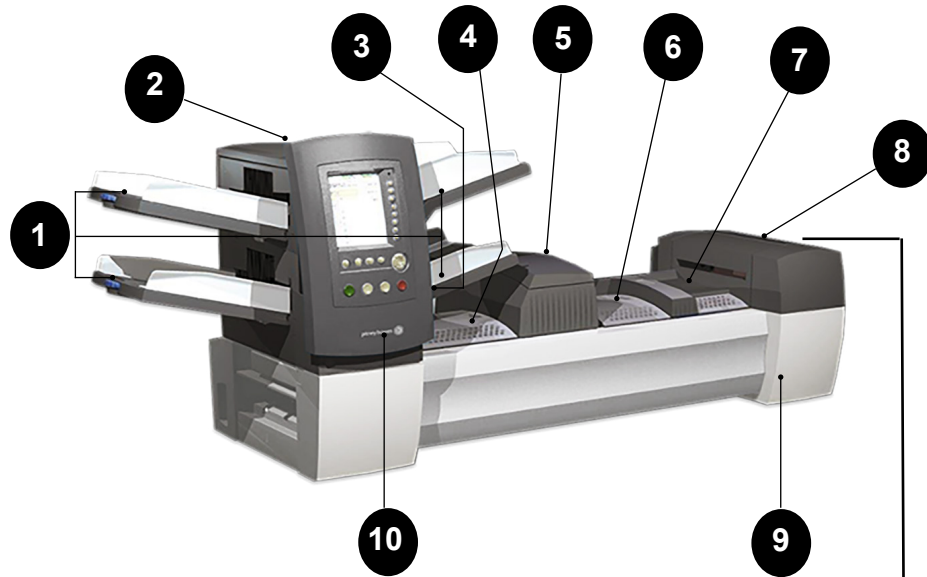

FPI 5100/6100 System

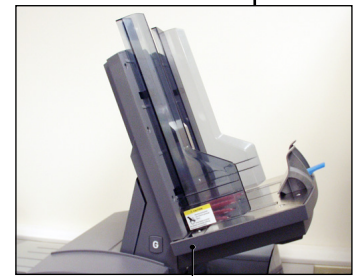

11

FPI 7100/8100 only

<p>1</p>	<p>Feeder Tower Trays - feed sheets or inserts to the feeder tower.</p>
<p>2</p>	<p>Feeder Tower - is a two-sided tray holder/material feeder. NOTE: If enabled, the lower left tray is assigned with the letter "A" on the Mail Piece Icon Tree. When a High Capacity Envelope Feeder is not part of the system configuration, this Tray is the primary tray for feeding envelopes designated for a given job.</p>
<p>3</p>	<p>Manual Feeder - allows you to manually feed stapled or unstapled sets of up to 5 sheets of 20 lb (80gsm) paper. The machine waits for each set to be manually fed before folding and inserting the set automatically into the envelope. The Manual Feed option is available during job creation. Inserts and/or sheets from other trays can also be added to the job.</p>

4	Pre-fold Accumulator - is a staging area for the material that needs to be collated together and then sent to the folder.
5	Folder - applies one of the available fold types to sheets.
6	Post-fold Accumulator - is a staging area for the folded sheets to meet any inserts that are to be included.
7	Insertion Area - is the part of the transport where the collation intended for a single addressee is inserted into an outer envelope.
8	Moistener, Closer, Sealer - Brushes sweep across the envelope flap to wet the glued area of the flap. The letter-size envelope then moves through the closer and sealer areas of the unit to complete the mail piece.
9	Sealing Solution Bottle - is located inside an opening cover at the front right side of the machine. It provides sealing solution to the envelope sealing system.
10	Control Panel - allows you to run the machine and configure job settings. It also displays the machine status and shows loading instructions and details of the job. <i>(Detailed information included in this section.)</i>
11	High Capacity Envelope Feeder (FPi 7100/8100 only) - holds at least 500 letter-sized envelopes. It feeds directly to the insertion area.

Control Panel Identification



1	LED Status Indicator
2	Screen Option Keys - allow you to define settings for up to 24 jobs that you can store in the system's memory. These keys also provide the means to edit any of the stored jobs.
3	Fixed Function Keys - allow you to access the system's built-in tools that appear on the screen (such as the system's help file).
4	Screen Navigation Keys - allow you to move UP/DOWN and right/left in the Display and to apply selections that you've made.
5	Machine Action Keys - control hardware components and mechanical movements.

Screen Option Keys

The eight screen option keys correspond to options on the screen, and therefore have no dedicated labels. Use these keys to highlight an item in a displayed pick list and/or to select the associated menu, item, action, or option.

Fixed Function Keys

Each of the four fixed function keys has an assigned function that is enabled or disabled based on the screen that displays.

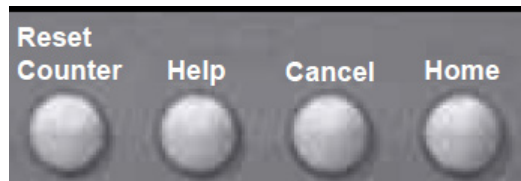

Reset Counter	<ul style="list-style-type: none"> • <i>Piece Counter</i> is a cumulative counter; it increments for each completed mail piece. • <i>Batch Counter</i> counts up to a set number. It increments one count for each completed mail piece that the system detects. The system stops when it reaches the batch count. • If your system has a flats sealer, the <i>Mark Piece Count</i> option is available. It allows you to reset the counter for the envelope edge mark to zero. • <i>Reset Both</i> allows you to reset both the piece counter <i>and</i> the batch counter to zero.
Help	Select Help for information about the screen that currently displays and for access to the entire Help file.
Cancel	Select Cancel to return to the previous screen.
Home	Returns you to the Home screen for the current job. The current job automatically includes any changes made while editing the job. Changes are not saved until you choose Save Job . Jobs that were changed but not saved have an asterisk (*) next to the job name (top of the Home screen)

Machine Action Keys

The four machine action keys run the system.

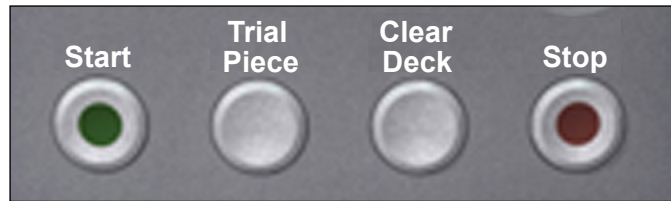

Start	Press this green-colored Start key to begin running the selected job
Trial Piece	Press Trial Piece to do a test run on your job. One complete mail piece will be prepared.
Clear Deck	Press Clear Deck to rid the system of materials currently in process in the paper paths. NOTE: Only press Clear Deck when prompted by the system to minimize lost material and manual mail piece generation.
Stop	Press Stop to finish in-process mail.

Screen Navigation Keys

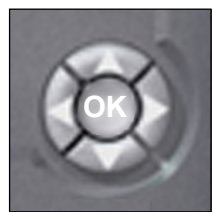
The screen navigation keys move the cursor on the screen to highlight items in the Mail Piece Icon Tree. The screen navigation keys consist of a two-tiered circular button.	
UP/DOWN and LEFT/RIGHT arrow keys, on the outer tier of the button, move the cursor UP/DOWN and LEFT/RIGHT on the screen.	
OK button, on the inner tier of the button, applies the selection that you made with the arrow keys.	

Change the Language Display

1. From the Home screen, select **Menu**.
2. From the Menu screen, select **Change Language**, a list of available languages displays.
3. If necessary, use the **Next** and **Previous** options to view additional languages on the list, and select the appropriate language.
4. Select **Finished**.
5. Press **HOME** to return to the Home screen.



How the System Works

Transport Deck

The transport deck accepts material from the feeder tower and moves it through the various modules to produce a finished mail piece.



Mail Piece Path

Material from the feeder trays comes down the feeder tower in a pre-defined order. Material moves rapidly from one station to the next in the transport deck to produce a finished mail piece that is dropped into a stacking bin or onto an optional high capacity output stacker. A brief description of the function of each module in the paper path is presented here.

Pre-fold Accumulator

The pre-fold accumulator is the first stop in the paper path. The pre-fold accumulator is a stacking place for the material that needs to be collated and folded. When the appropriate components for one mail piece finish collating on the pre-fold accumulator, they move into the folder.

Folder

The stack of collated sheets exits the pre-fold accumulator and moves into the folder. A fold is applied to the stack and the collation moves to the post-fold accumulator.

Fold types offered:

- C Fold
- Z Fold
- Single Fold
- Double Fold
- No Fold

(An optional inverter may be used for some address location/fold type combinations.)

Post-fold Accumulator

The accumulation of folded sheets exits the folder onto the post-fold accumulator area. Other components of the mail piece, such as a Business reply envelope or a pre-folded insert, are added to the accumulation in the post-fold accumulator area. When all components are present, the stack moves to the insertion area.

Insertion Area

The contents of the mail piece meet the outer envelope at the insertion area. The envelope arrives at the insertion area with its front face down and flap open. Envelope openers open the envelope wide enough to allow the contents to be slid inside.

Folder Bypass Path

The outer envelope, fed from the feeder, that will contain the collated media runs through the bottom part of the transport deck. The route this envelope travels is known as the folder bypass path.

Moistener, Closer, Sealer

As the envelope passes over the moistener, brushes sweep across the top of the flap to wet the glued area of the flap. The envelope is then inverted and slid through the closer and sealer portion of the system to complete the mailpiece. From there, the mailpiece is dropped onto a stacker.

System Covers

Transport deck covers open to provide access to the rollers in the main paper path.

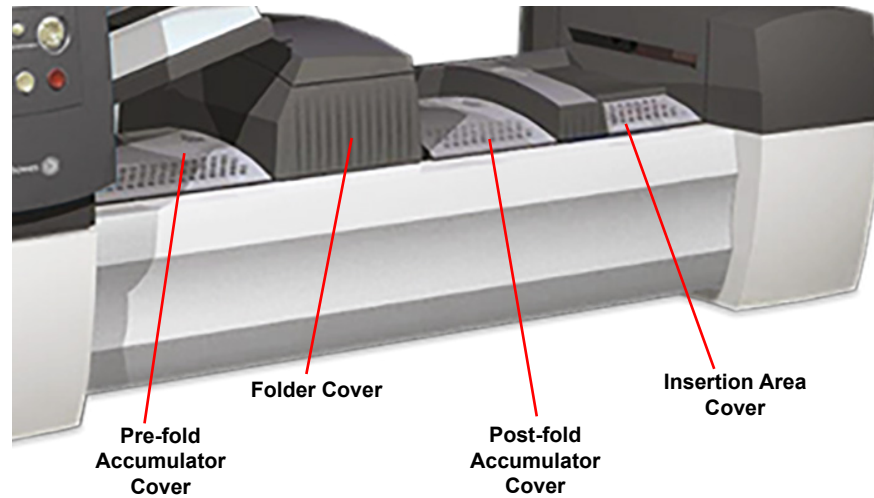

The three covers on the front side of the system open to provide access to the paper release knobs.

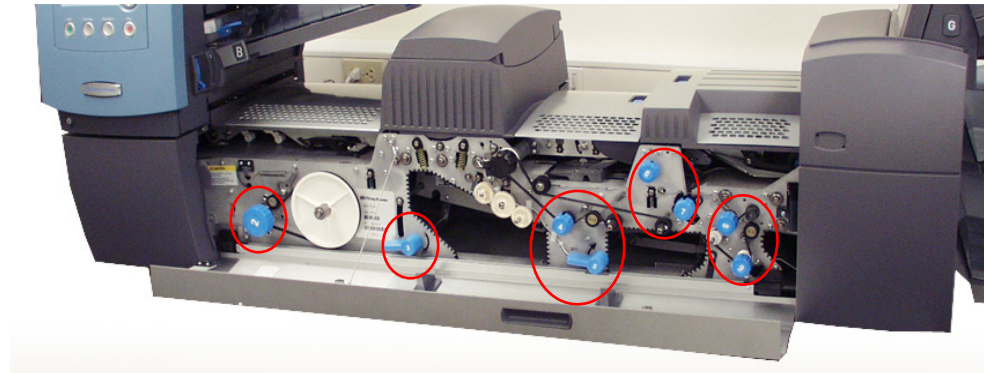

NOTE: The tower base cover is interlocked with the main transport deck cover. You must open the main transport deck cover *before* opening the tower base cover.

CAUTION

Moving mechanism can result in personal injury.

Keep hands, long hair, ties, jewelry and loose clothing away from moving parts.

Open the Covers

Main Transport Deck Cover

To open the main transport deck cover:

1. Place your fingers into the slot on the top of the cover.
2. Pull down gently. A security tie keeps the cover within the recommended range of movement.

IMPORTANT! *Do not* lean on the open cover.

Main Tower Base Cover

To open the tower base cover:

1. Open the main transport deck cover.
2. Pull down on the tower base cover handle.

Close the Covers

To close the lower tower and/or the main transport deck cover, push the cover up until it is seated in place on the system deck.

Paper Release Knobs/Levers

There are ten paper release knobs and levers on the front side of the system. Each knob provides the means to turn rollers and move material out of the area in which it stalled. Each paper release lever opens an area of the system and allows you to clear any material that may have stalled.

The following image indicates the various knob/lever locations, as well as the areas each knob moves material through and each lever opens.

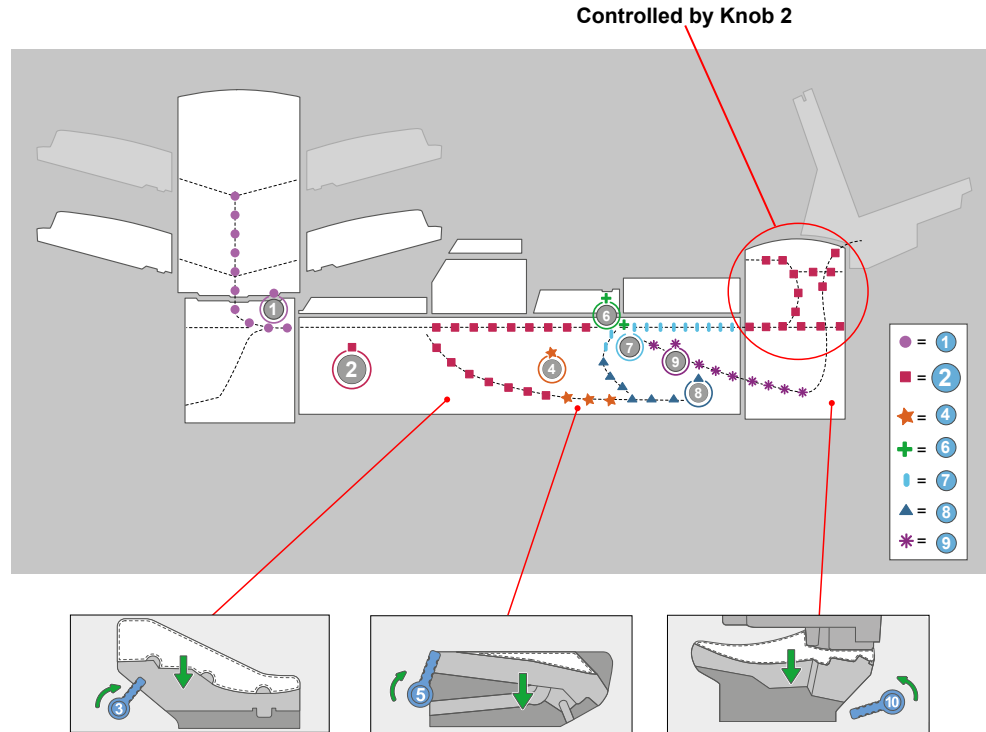

Feeder Tower

The feeder tower is a two-sided tray holder/material feeder that stands at one end of the unit. Unlocking a latch on the left side of the tower opens it to expose feeder exit and tower transport rollers. This makes it easy to access material that may stop as it exits the tower.



Depending on the system configuration, the tower accepts two or four feeder trays. There are two types of feeder trays - sheet and insert trays. The required tray type is based on the type of material selected for a given job.

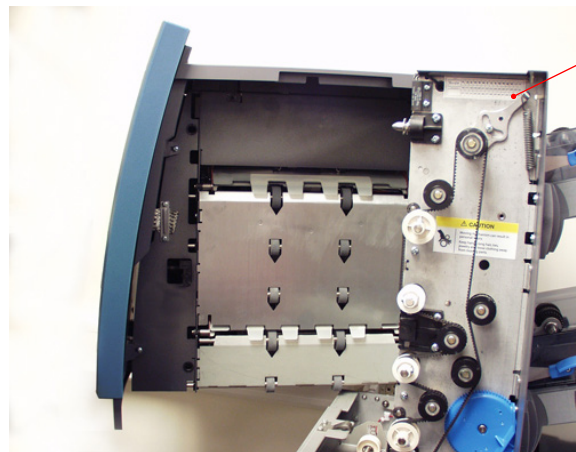

Push latch up to open Tower cover



Two-sided Feeder Tower - provides easy access to feed rollers

 CAUTION	
	<p>Moving mechanism can result in personal injury. Keep hands, long hair, ties, jewelry and loose clothing away from moving parts.</p>

Add-On Modules

High Capacity Sheet Feeder (HCSF)

The HCSF add-on module attaches to the feed tower end of the system to provide greater upstream volume. The HCSF has two feeder trays and a horizontal transport. Each Feeder Tray holds up to 1000 sheets of 20 lb. (80 gsm) paper.

The system can handle up to two High Capacity Sheet Feeders. Each HCSF attaches to the next to form an upstream flow from one to the other and finally into the main system.

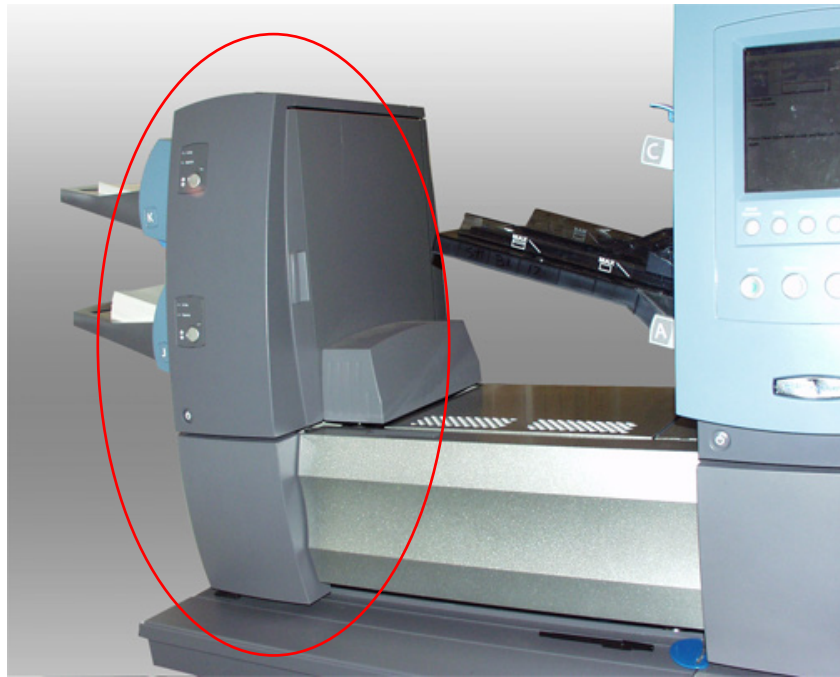

Flats Sealer

The flats sealer closes the flap, seals the envelope, and sends it on to the next module downstream. The Flats Sealer also contains an envelope edge marker.



Vertical Power Stacker

The vertical power stacker is a compact, powered, bottom-feed stacker that connects to the output of several inserting systems, including the FPi inserters.

Horizontal Belt Stacker

Belt Stacker - Letter or Flats

The Horizontal Belt Stacker can be used in Right Angled or In Line configuration with the FPi inserters.

Tandem Belt Stacker - Letter and Flats Mail

A particular configuration of the stacker is available for the FPi inserters that allows automatic stacking of 'Letters' and 'Flats' simultaneously.

Exit Transport

The Exit Transport connects to the inserter and can be mounted to other output devices while maintaining flats envelope functionality.

Optional Features

There are several optional features you may have on your inserter system.

File Based Processing

This solution uses documents with barcodes that enable a dedicated computer to keep track of the mailpiece during the process. The barcode tells the inserter how to build each mailpiece to the specified completion.

Exit Options

The exit portion of the system accepts a variety of options. The letter drop stacker and the flats drop stacker are standard options for all systems.

Mail Machine Interface (MMI)

The Mail Machine Interface (MMI) enables communication between the inserter and the mailing systems via a USB connection.

Access Rights

There are two security modes available on the system:

- **Login Not Required Mode** - requires four-digit access code to perform supervisor and manager functions.
- **Login Required Mode** - sets up access levels and requires a user ID and password for all system operator, supervisor, and manager functions.

User Access Levels

The system has three levels of user access:

- Operator
- Supervisor
- Manager

User	Access Rights
Operator	Access to selecting and running a job, limited scanning activities, and running a Swift Start job. System operators may be required to log in and out of the system if a security mode has been enabled.
Supervisor	Access to all operator functions as well as programming a job, saving a job, and deleting a job (with the correct access code <i>or</i> user ID and password).
Manager	Access to all of the above functions <i>plus</i> exclusive rights to manage other users (i.e. assign/restrict functions and selecting the account mode).

NOTE: Depending on the security mode, the supervisor and manager access levels require entry of an access code *or* user ID and password. These are assigned by the system manager.

Log In

- When the **Login Required Mode** is enabled, entry of a user ID and password is needed to access the system.
- When **Login Not Required Mode** is enabled, entry of an access code is needed to access restricted functions.

NOTE: Managers assign the user IDs and passwords or access codes. User IDs can contain alphanumeric characters; access codes and passwords *must* be numeric only.

Login Required Mode

If Login Required Mode is enabled:

1. At the Select User screen, select the appropriate user ID.
(If necessary, select **Next** to view additional user IDs.)
2. Enter your password.

NOTE: Passwords are four-digit numeric codes. Numbers 1, 2, 3, 4 and 5 display on the first screen. Press "Next" to access numbers 6, 7, 8, 9, and 0.

3. Select **Accept** and the Home screen displays.

Login Not Required Mode

If Login Not Required Mode is enabled on your system and user IDs and passwords have been set up by the manager, the log in option displays on the Home screen.

Log Out

To log out, on the Home screen, select **Log Out**.

NOTE: You must log out of the system in order for the next operator to log in.

2. *Display Screen*

Contents

Display Screen Overview	2-3
Header Area	2-4
Footer Area	2-4
Status Area	2-5
Navigating Options	2-8
Icons and Letters	2-9
Envelope Icons	2-9
Fold Icons	2-9
Sheet Icons	2-10
Insert Icons	2-11
Feeder Assignment Icons	2-12
Other Icons	2-12



This page is intentionally blank.

Display Screen Overview

The display screen is divided into three major areas:

- **Header**
- **Status**
- **Footer**

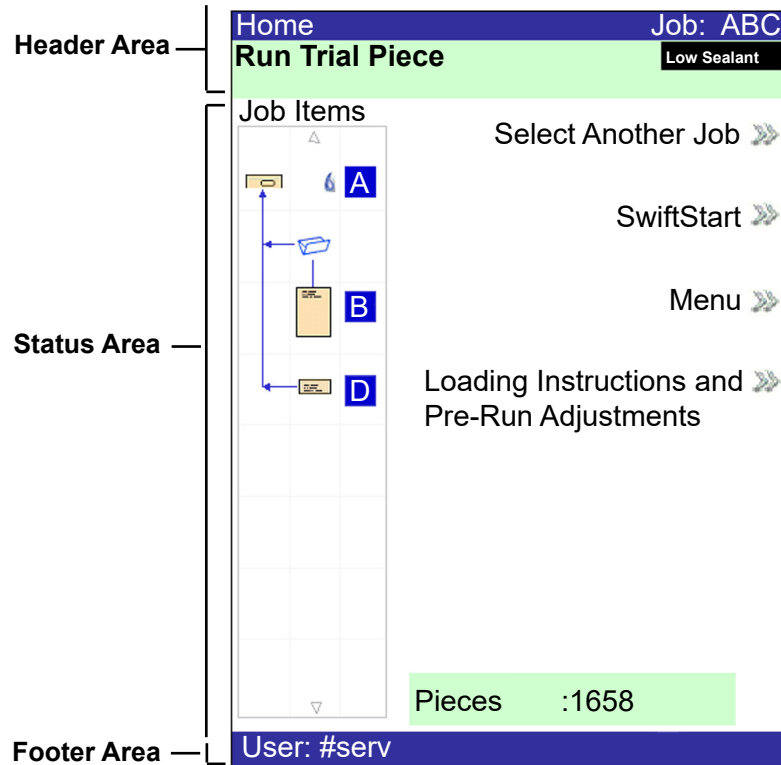

Header Area

The header area has two colored bands that run across the top of the screen: the top blue band, the bottom green band.

The left side of the top blue band displays the name of the current screen. Depending on the screen, the **Job Name** may show on the right side.

The green band displays instructions and screen navigation directions.

The top (blue) band displays the name of the screen and Job.

If the job uses the attached printer, the mail run name displays in the middle of the top (blue) band.

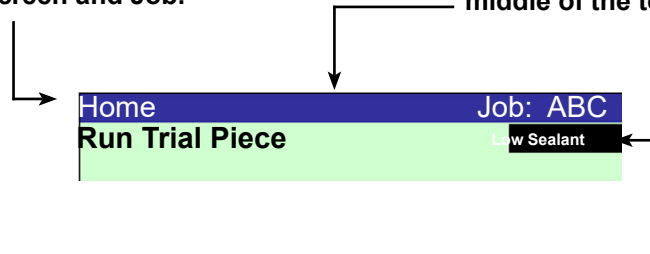

The bottom (green) band displays the instructions and screen navigational directions.

Footer Area

The footer area contains data across the bottom of the Home screen to identify the user and account.



Status Area

The status area displays information about the task(s) you are performing. This area contains any or all of the following:

- Mail Piece Icon Tree
- Item Orientation
- Options
- Data across the bottom of the screen (Home screen only) - batch count, piece count, and User ID

Mail Piece Icon Tree

The Mail Piece Icon Tree gives a road map of icons to visually help guide you through how a mailpiece will be put together and processed.

- It displays an icon for each component in the mail piece and a fold icon, if the material is to be folded.
- The icons are arranged in the order in which the mailpiece components will be collated. The outer envelope icon shows at the top of the tree.
- A letter appearing alongside the icon designates the Feeder Tray assignment; a small blue droplet icon indicates that the seal feature is enabled.
- The Mail Piece Icon Tree is located on the left side of the screen in the status area.
- Each icon has one darker edge, either at the top or bottom, that indicates the leading edge of the material. The leading edge is the edge that feeds into the machine first. (For example, a sheet that must be loaded face up with the top of the sheet leading would be represented by a "face-up" sheet icon containing a "leading edge" line on top.)

Leading Edge

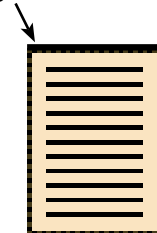

Sheet, Face Up

- A **feeder assignment letter** is placed alongside the icon to indicate the feeder tray the material is loaded into. Two or more feeder assignment letters alongside a single icon indicate that feeder trays have been **linked**. The material should be loaded in all the feeder trays indicated. During a job, when one feeder tray is empty, the feed will automatically switch to the next linked feeder tray, in a continuous cycle.
- If **double detect** is in use, the double detect icon appears to the left of the relevant icon.

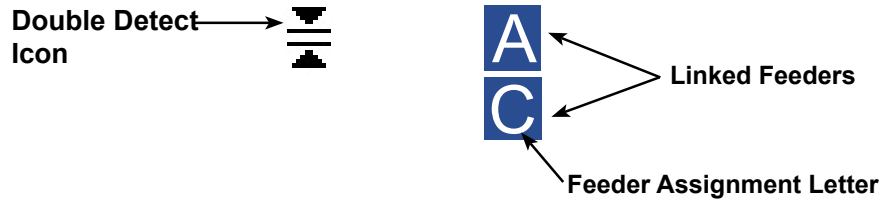

- If any sheet feeder(s) are programmed to **feed multiple sheets**, a modified icon indicating multiple sheets appears with a number showing the number of sheets in the set.

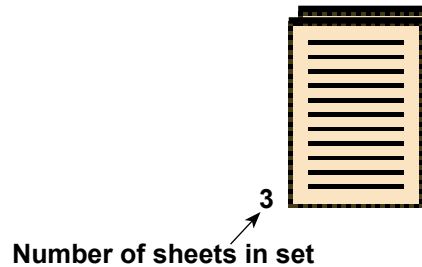

- On **scanning (OMR or Barcode)** jobs, a variable number of sheets might be fed under control of the OMR / barcode marks. In this case, a small letter "n" will appear in place of the number.

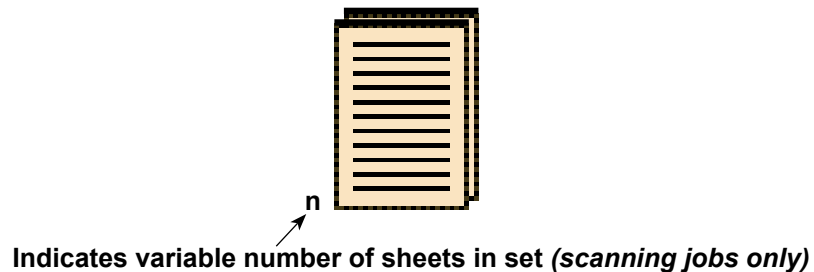

Mail Piece Icon Tree Example

In the Mail Piece Icon Tree, each icon displays important information about the mail piece component it represents. The following diagram identifies information conveyed by the icon and how it assists you in loading and running a job.

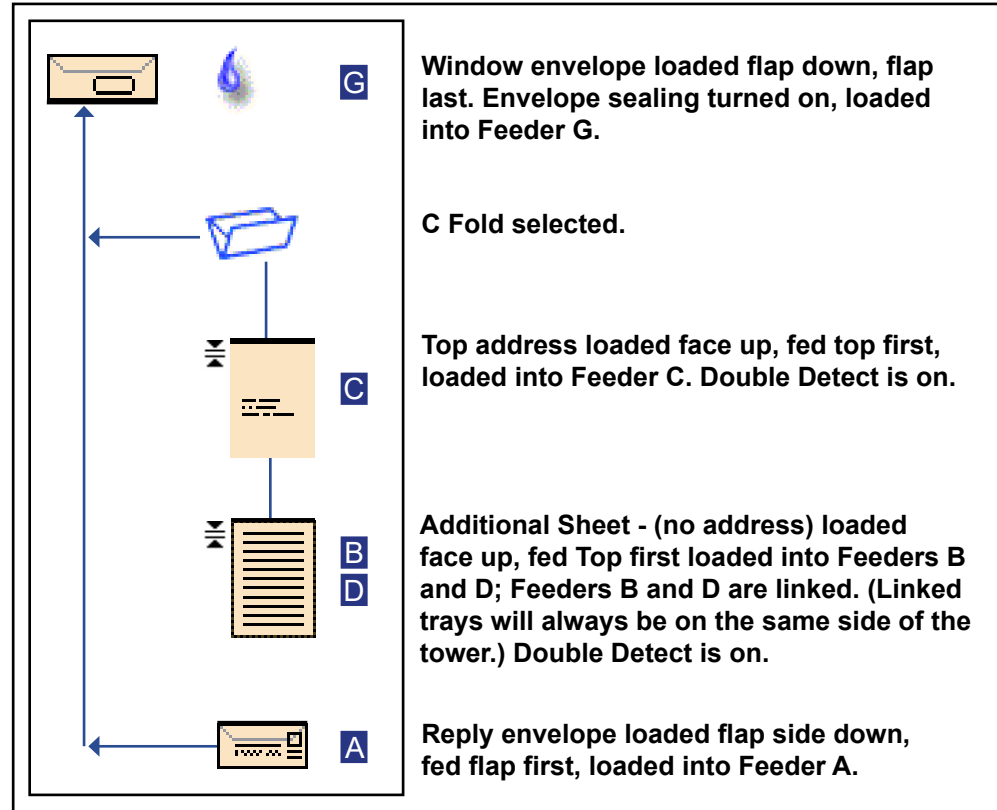

* In the example above, the top address, additional sheet and C fold icons represent a set. That is, the Top Address and Additional Sheets are accumulated together, into a collation and the C Fold is applied to the collation.

* An insert (see the Reply Envelope icon) always appears as a single set within the Mail Piece Icon Tree.

NOTES:

- Lines connecting the icons indicate the way the mail piece is assembled. The outer envelope is at the top of the icon tree.
- Making any change to the job settings can cause the feeder tray assignments to change in the Mail Piece Icon Tree.
- Any time the job set up changes, be sure to check the Mail Piece Icon Tree for changes in the feeder tray assignments.

Navigating Options

The right side of the display screen lists the options and functions available for the current screen. Once you make a selection, more options for that selection display. Refer to the example screens below.

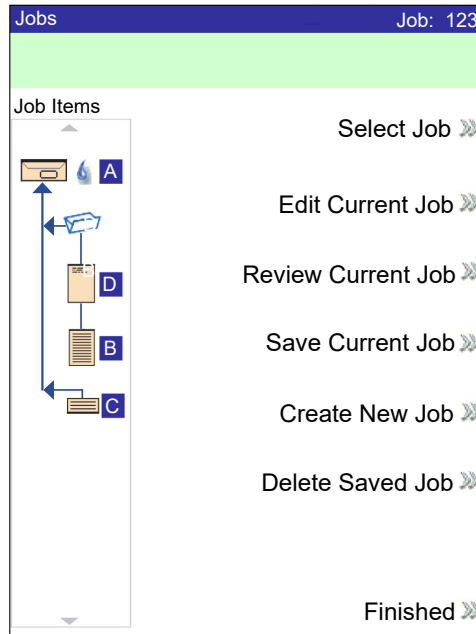

Example: Functions

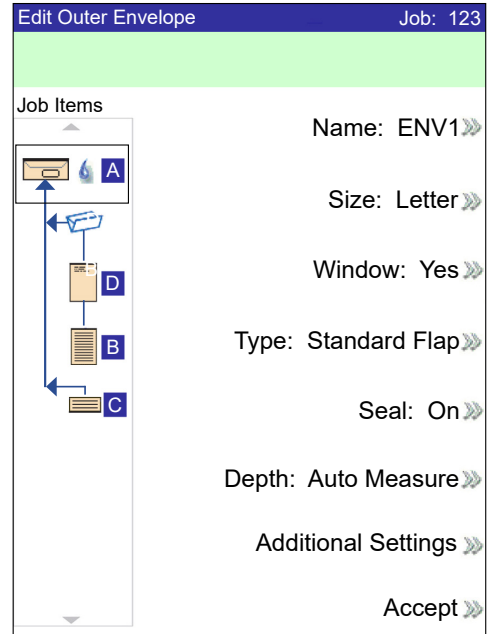

Example: Options for the Selection

NOTE: Two chevrons (>>) indicate that there is a submenu of options. One chevron (>) indicates there is a toggle between two choices, like **Yes/No** or **On/Off**.

Icons and Letters

The following tables provide descriptions of the icons on the display screen.

Envelope Icons

	Tower Feeder Orientation: <i>flap side down, flap first.</i>	HCEF* Orientation: <i>flap side down, flap last.</i>
Non-Window Letter Envelope		
Window Standard Flap Envelope		
Window Forward Flap Letter Envelope		
Window Bottom Flap Letter Envelope		
Non-Window Flat Envelope		N/A
Window Standard Flap Flat Envelope		N/A
Window Forward Flap Flat Envelope		N/A
Window Bottom Flap Flat Envelope		N/A

*High Capacity Envelope Feeder



















Fold Icons

No Fold	C Fold	Z Fold	Single Fold	Double Fold

Sheet Icons



	Orientation: <i>face up, top first.</i>	Orientation: <i>face up, bottom first.</i>	Orientation: <i>face down, top first.</i>	Orientation: <i>face down, bottom first.</i>
Sheet, Not Personalized				
Sheet, Top Address				
Sheet, Middle Address				
Sheet, Bottom Address				
Multiple Sheets, Not Personalized				
Multiple Sheets, Top Address				
Multiple Sheets, Middle Address				
Multiple Sheets, Bottom Address				

Insert Icons

	Orientation: <i>face up, top first.</i>	Orientation: <i>face up, bottom first.</i>	Orientation: <i>face down, top first.</i>	Orientation: <i>face down, bottom first.</i>
Slip or Generic Insert				
Reply Envelope		N/A	N/A	N/A
Reply Card				
Multiple Slips or Generic Inserts				
Multiple Reply Envelopes		N/A	N/A	N/A
Multiple Reply Cards				

Feeder Assignment Icons





Feeder assignment is indicated by a letter in a grey square to the right of the job item icon in the Mail Piece Icon Tree. The letter that will display in the blue square depends on the assigned feeder.

- **Single Feeder Assignment** is indicated by one grey square. 
- **Linked Feeder Assignment** is indicated by two grey squares. 

NOTE: The table below provides a list of all possible feeder assignments. Available feeders depend on your system configuration.

Feeder Letter	Location	Position
A	Feeder Tower	Bottom left feeder
B	Feeder Tower	Bottom right feeder
C	Feeder Tower	Top left feeder
D	Feeder Tower	Top right feeder
G	High Capacity Envelope Feeder (HCEF)	N/A
J	High Capacity Sheet Feeder 1 (HCSF)	Bottom feeder
K	High Capacity Sheet Feeder 1 (HCSF)	Top feeder
L	High Capacity Sheet Feeder 2 (HCSF)	Bottom feeder
M	High Capacity Sheet Feeder 2 (HCSF)	Top feeder
X	Custom Feeder	N/A
Z	Attached Printer	N/A

Other Icons

Error Icon - appears in pop-up messages on display screen. Indicates message is an error message .	
Warning Icon - appears in pop-up messages on display screen. Indicates message is a warning message .	
Seal On Icon - appears in Mail Piece Icon Tree if sealing is on . Safe Seal Icon - appears in Mail Piece Icon Tree if safe seal is on .	
Double Detect Icon - appears in Mail Piece Icon Tree if double detect is on .	

3. *Run a Job*

Contents

Powering Up.....	3-3
Home Screen.....	3-4
Run a Job	3-5
Select a Job.....	3-6
Set Up Feeders and Load Material.....	3-7
Additional Adjustments	3-20
Pre-Run Adjustments.....	3-21
Feed a Test Envelope.....	3-21
Perform Width Adjustments (Outer Envelope Openers).....	3-22
Perform Length Adjustments (Inner Envelope Openers).....	3-23
Verify Settings.....	3-24
Manual Feeder	3-25
Adjust Manual Lever for Stiff Media Mode (FPi 8100 Only)...	3-26
Run a Trial Piece	3-27
Review Job Settings	3-29
Start the Job	3-30
SwiftStart™ Jobs.....	3-30
Running the Mail Machine Interface.....	3-31
Adjust Screen Brightness and Contrast.....	3-33
Set the Time and/or Date.....	3-34
Refill the Sealing Solution.....	3-35



This page is intentionally blank.

Powering Up



WARNING! Read the safety information in the front of this guide before connecting the system to power.

1. Connect the power cord to the socket on the back of the inserter.
2. Plug the power cord into a suitable power outlet. Verify the power outlet is near the inserter and is easily accessible.
3. Press the **ON/OFF** switch (located below the control panel) to start the power up process.

NOTE: If you have a High Capacity Sheet Feeder (HCSF), power on *before* you power on the base.

NOTE: When power cycling the system, be sure to power cycle any optional add-on equipment as well.

The system automatically conducts a number of checks to verify operational integrity. If any problems are detected, the system will display information directing you to a solution to the problem.

Home Screen

When the system completes the startup process, the Home screen displays. The last job run displays on the Home screen. Information about the job displays, along with the ability to select a different job, edit settings for the displayed job, use the SwiftStart™ feature, and view loading instructions for the selected job. *(If you need to adjust the screen brightness or contrast, refer to the Troubleshooting section for instructions.)*

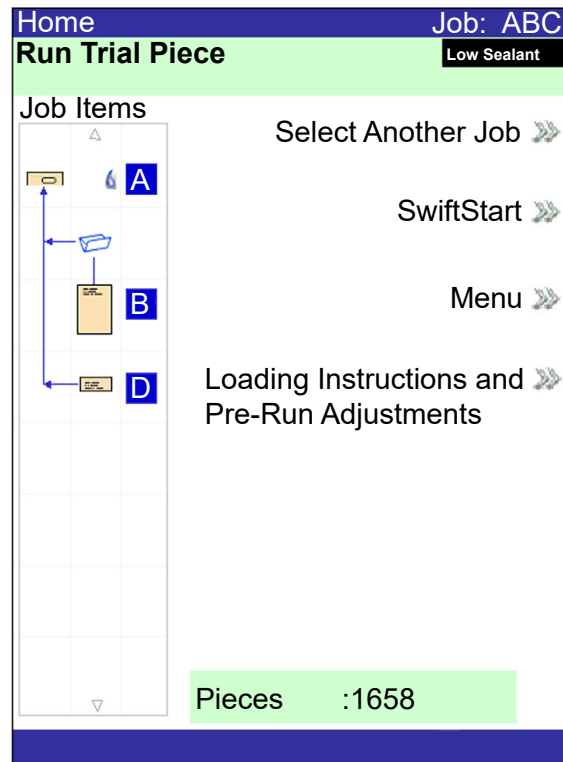

Home Screen

NOTES:

- The **Job Items** list represents the order in which the items in your mail piece will be shown. The first item (below an outer envelope) is the top document when the contents are removed from the envelope.
- The sheet and insert icons in the **Job Items** list represent the stack of material loaded into a feeder.

Run a Job

This section provides the instructions to run or edit a job. The content in this section assumes that the job to be run has been created and is in the **Saved Jobs** list in your system.

If the job does not exist, a Supervisor/Manager must create and save it. If the job requires modification, an operator can edit and run it, but saving it can be done only by a Supervisor/Manager. (Refer to the *FPI 5100/6100/7100/8100 Series Administrator Guide* for details on programming a job.)

There are five major steps involved with running a job. These steps need to be followed in the order listed:

- Select a Job
- Set up the feeders and load material
- Make pre-run adjustments (*if necessary*)
- Run a trial piece
- Start the job

Select a Job

If the job you want to run displays in the Home screen, proceed to *Running a Trial Piece* in this chapter. If the desired job does not appear, follow the steps below to select a job:

1. From the Home screen select:
 - **Select Another Job** to view a list of saved jobs, then skip to step 3.

OR

- Select **Menu>Jobs>Select Job**. The Select Job Type screen displays provides access to all the jobs in your system and displays three categories to help you search for the job you are looking for:

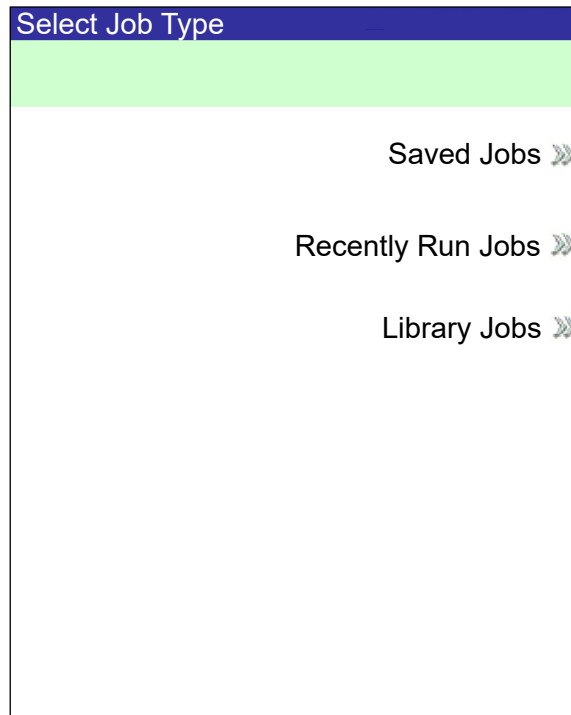

Select Job Type Screen

- **Saved Jobs** - displays list of jobs that have been created and saved.
 - **Recently Run Jobs** - displays list of the last eight jobs run; also shows each job's name and the date/time the job ran.
 - **Library Jobs** - displays the names of the pre-defined jobs that came loaded on your system.
2. Select the desired category to display the list of jobs available in that category.
 3. Select the desired job from the list.
 - If the job does not appear on the first page, use the UP/DOWN arrow keys to scroll through the list.
 - When a job is highlighted in the list, the Mail piece Icon Tree for the job appears on the display.

Set Up Feeders and Load Material

Once you select the job you want to run, you need to set up the system:

- **Attach Trays to the Feeder Tower**, if prompted
- **Load Material into the Trays** as directed by the Mail Piece Icon Tree and the loading instructions for the selected job.
- **Load the HCEF (High Capacity Envelope Feeder)**, if necessary

NOTE: If you have a HCSF (High Capacity Sheet Feeder) on your system, material needs to be loaded into it.

Attach Trays to the Feeder Tower

The procedure for attaching and loading either type of tray to the feeder tower for either type of tray are basically the same:

NOTE: Use both hands when attaching or removing a tray.

1. Align the back end of the tray with the tray mounts in the feeder tower.
2. Lift the separator by pushing up on the separator lift Lever (located on the side of the feeder tower).

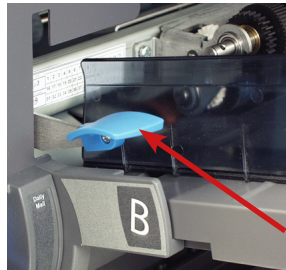

Push the lever up to lift the separator



Lift the separator and slide tray into tray mounts

- Slide the tray into the tray mounts until you feel the tray seat into place.

NOTE: The tray is seated properly when the notch on the bottom of each side of the tray is seated in the groove on each of the tray mounts.

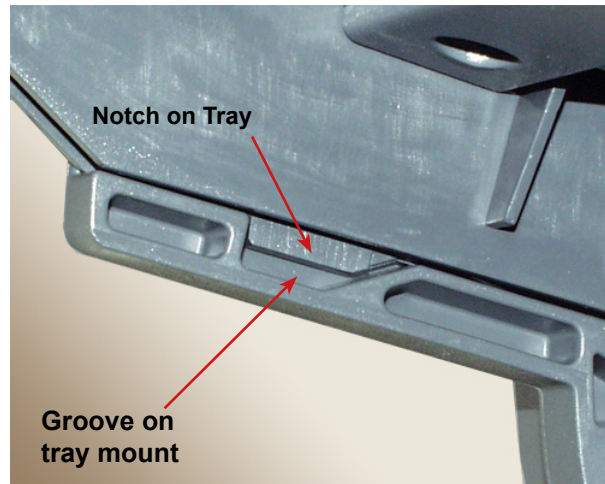

Tray Seated Properly in Tray Mount (bottom view)

- Pull straight back on the tray slightly, and at the angle the tray sits, to ensure it is attached securely. If it isn't sitting right, repeat the procedure until the tray seats properly and securely.

Remove Trays from the Feeder Tower

To remove a sheet or insert tray:

- Grasp the open end of the tray and lift up.
- Slide the tray out until it clears the grooves in the tray mount.

Load Material into the Trays

Follow the loading instructions before you run a job. The loading orientation may change depending on the feeder assignment and job settings.

(i.e. One Feeder may need to be loaded bottom first and another top first.)

It is important to loosen (fan) any items in the stack that may be stuck together *before* you place the material in the tray. To do this:

1. Hold one end of the stack in one hand.
2. Flip through the opposite end of the stack with your other hand.
3. Repeat this with the other end of the stack.



Loosen (Fan) Material

Tray Information

The Mail Piece Icon Tree in the Home screen provides information about each item in the mail piece. Each icon represents a document in the job.

- Use the arrow keys to highlight any document icon. When an icon is highlighted, any or all of the following information will display:
 - Graphic of the document/media type
 - Tray type into which the document/media should be loaded
 - Orientation of the document in the tray
- Feeder assignments are determined by the inserter to best optimize the job. This means they are assigned only after a job is selected. Also note that after editing a job the feeder assignments may change.

Adjust Tray Side Guides

A grooved, blue side guide adjuster is located at the open end of each tray. This adjuster controls the opening and closing of the tray side guides.

To open or close the side guides on the feeder tower trays:

1. Place the palm of your hand against the side guide adjuster at the open end of the tray.
2. Use the palm of your hand to turn the side guide adjuster:
 - Turn the adjuster counterclockwise to move the side guides in towards the material.
 - Turn the adjuster clockwise to move the side guides out and away from the material.
3. When the side guides contact the material in the tray, remove your hand from the adjuster. The guides automatically spring back from the material and leave a space about the thickness of an envelope, 1/16-inch (1.4 mm). This spacing allows for proper material feeding.

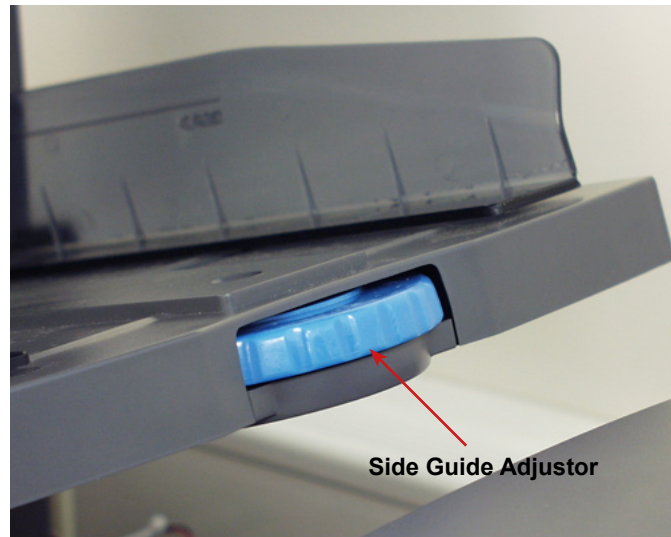

NOTES:

- *Do not* pull or push on the side guides to move them.
- Always use the side guide adjuster to move the side guides.

Load a Sheet Tray

Sheet trays feed flat, unfolded material. Be sure to keep your stack of materials at or below the fill marks on the tray walls to avoid feed problems.

NOTE: To view a demo of the sheet tray loading and side guide adjustment processes: go to the Home screen and select **Loading Instructions and Pre-Run Adjustments**. Use the UP/DOWN arrow keys to select a sheet (fed by the feeder tower) from the Mail Piece Icon Tree, then select **Feeders Setup Demo**.

To load media into a sheet tray:

1. Using the side guide adjustor, open the sides of the tray wide enough to clear the width of the material.
2. Fan a small stack of material and place it into the tray in the orientation specified in the loading instructions on the Home screen.

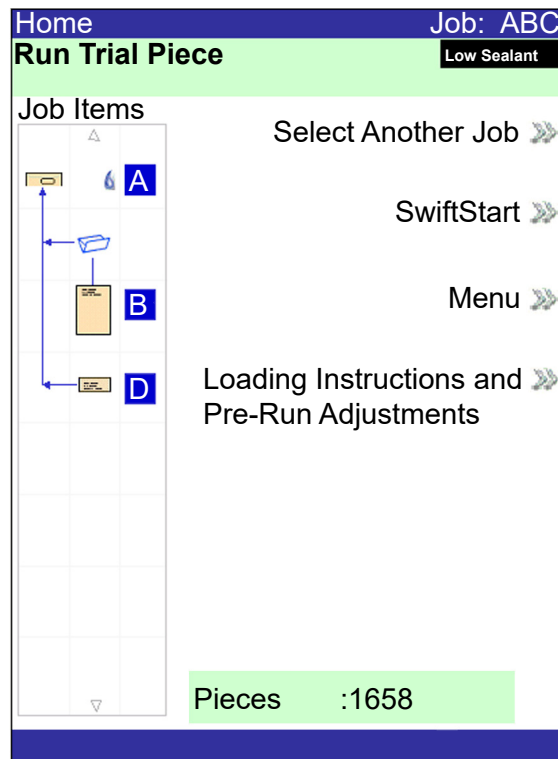

3. Using the side guide adjustor, move the side guides in until they lightly touch the material on both sides.
When you release the adjustor, the guides automatically spring back to a position that allows for proper clearance during feeding material.
4. Lift the separator and load material into the tray.

NOTE: Do not load material above the maximum fill line in the tray.

Load Sheets into the HCSF

1. After loosening the pages of the stack of sheets, turn the HCSF tray Side Guide Adjustor counterclockwise to open the Tray wide enough to accommodate the stack of sheets.

NOTE: The side guide adjustor is located below the tray indicator letter.

2. Load approximately 1-inch of material into the tray (in the orientation specified in the loading instructions on the Home screen). Green lights on the front panel of the HCSF indicate the material is loaded and the HCSF is operable.

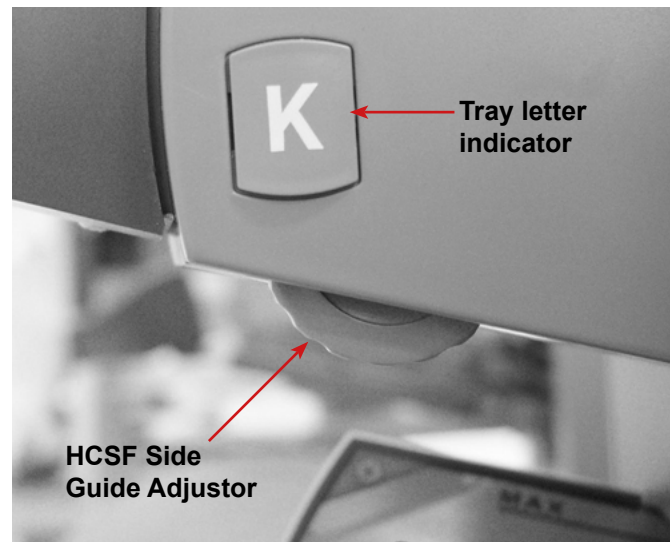

3. Turn the feeder tray side guide adjustor clockwise until the side guides touch the material, and then back off slightly.

TIPS:

- For collations of 20 to 25 pieces, back off one full revolution (approximately .1" / 2.5 mm) of the side guide adjustor.
- Turn **clockwise** to move **in**, **counterclockwise** to move **out**.

4. Load the remaining paper up to the fill line.
5. Repeat steps #2-5 for each remaining HCSF tray.
6. Press the button on the front of the HCSF for each of the trays. The loaded tray(s) will move into position for feeding.



Adjust the HCSF Guides

If the sheet width is different from the sheet width used in the previous job, you need to adjust the HCSF guides for the new job.

IMPORTANT: Make sure you enabled the High Capacity Sheet Feeder Trays before performing this adjustment.

1. From the Home screen, select **Loading Instructions>Pre-Run Adjustments>HCSF Guide Settings**.
2. Select the feeder to be set up.
3. Press **TRIAL PIECE**.
4. Open the front and top covers of the enabled HCSF accumulation area.

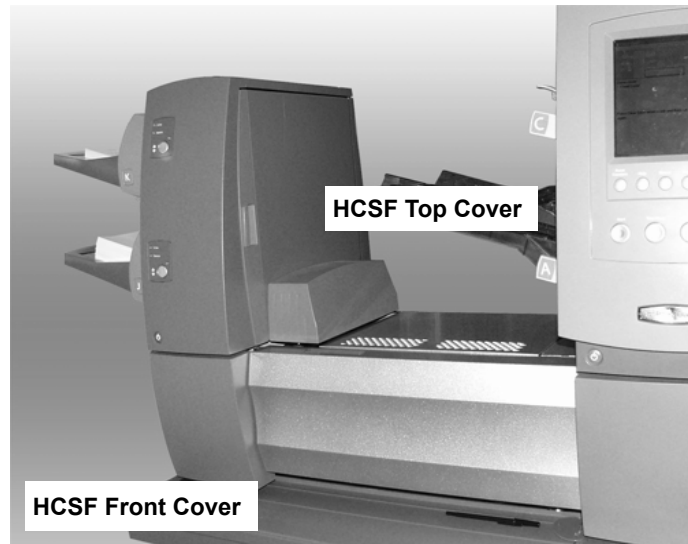

5. Set the length guide:
 - a. Pull the length knob (knob 12) straight out.
 - b. Turn the knob to position yellow line on the length guide bar at the trailing end of the sheet.
 - c. Release the length knob once the length guide is properly placed.

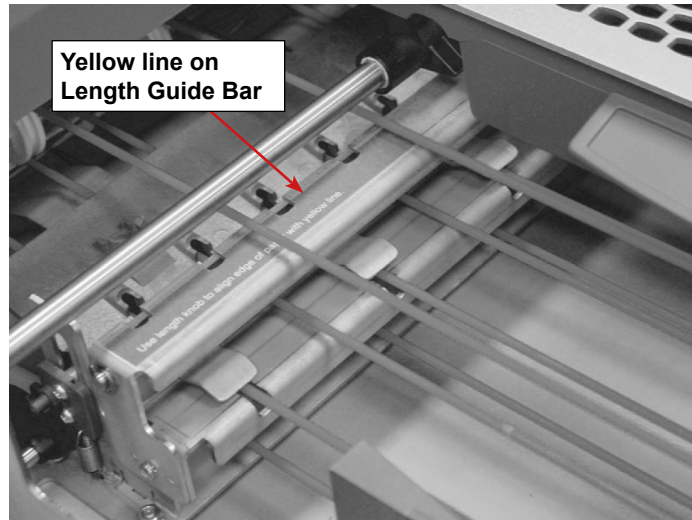

6. Set the width guides:
 - a. Turn the right-hand knob on the side of the sheet transport to move the width guides.
 - b. Move the width guides until they just make contact with the sides of the sheet, then back off slightly (approximately 1/3 of a turn). The sheet should lay flat, and not buckle.
7. Close the front and top covers of the HCSF accumulation area.
8. Press **CLEAR DECK** to remove any material in the paper paths.
9. Repeat steps #3 - 8 to adjust the length and width guides until the sheet aligns properly.
10. Repeat the entire procedure for each additional HCSF on your system.

Load Insert Trays

Insert tray feed items that do not need folding include envelopes, cards, booklets, slips and pre-folded media. Insert trays have two sets of maximum fill lines - one set for slips, and a second set for envelopes.

NOTE: To view a demo of loading the insert tray and adjusting the side guide adjustment processes: go to the Home screen and select **Loading Instructions and Pre-Run Adjustments**. Use the UP/DOWN arrow keys to select an insert in the Mail Piece Icon Tree, and select **Feeders Setup Demo**.

To load material into an insert tray:

1. Use the sled locking lever to slide the sled to the end of the tray. The sled automatically locks in place.
2. Using the side guide adjustor, open the sides of the tray beyond the width of the material.
3. Stand a stack of material straight up and against the front end of the tray, and in the orientation specified on the Mail Piece Icon Tree and Home screen loading instructions.



4. Using the side guide adjustor, bring the sides of the tray **lightly** against the material, then release the adjustor. The guides will automatically spring back to a position that will allow for proper clearance during feeding of the material in the tray.
5. Finish loading the tray to the appropriate fill line for the insert type.
6. Tilt the material slightly toward the back of the tray.
7. While holding the material in the tilt position, *gently* pull up on the sled lock release to unlock it. Allow the sled to move forward.
8. Slide the sled until it contacts the end piece in the stack of material, and then release your hold on the material.

NOTE: Items in the Mail Piece Icon Tree on the display represent the material in the selected job. Use the arrow keys to highlight any icon to view a picture of the orientation of material in the tray, and the designated location of that tray on the feeder tower.

Load the High Capacity Envelope Feeder (HCEF)

The HCEF holds up to 500 envelopes. To load envelopes into the HCEF, you will need to adjust the side guides, wedge, and separator gap. Before you begin making any adjustments, fan a stack of envelopes and remove any that are nested, curled or damaged in any way.

NOTE: To view a demo of the wedge and separator gap adjustment processes, go to the Home screen. Select **Loading Instructions and Pre-Run Adjustments.**, Use the UP/DOWN arrow keys to select the envelope being fed by the HCEF, and select **Feeders Setup Demo.**

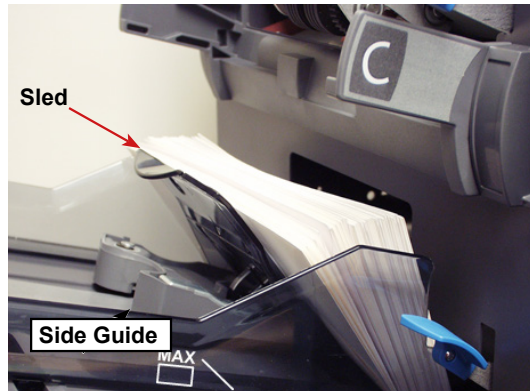

Adjust the HCEF Side Guides

1. Place an envelope between the side guides.
2. Using the adjustor knob, bring the side guides in to lightly touch the envelope.
3. Release the knob. The guides will spring back to the correct position to allow free sliding of the envelope between the side guides.
4. Make sure the envelope slides freely between the side guides when it is placed flat on the red feed belts.

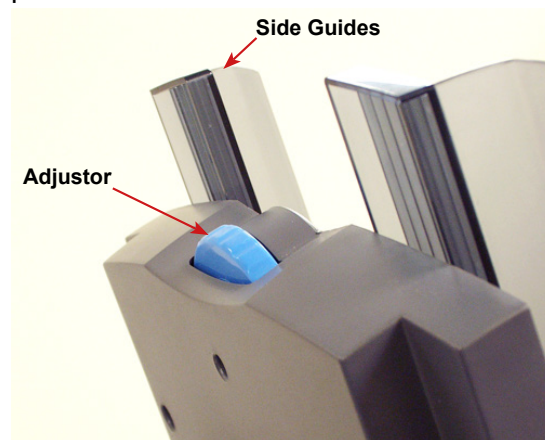

Adjust the HCEF Wedge

1. Insert an envelope into the HCEF with the bottom edge of the envelope against the center guide, in line with the two screws. The top edge of the envelope (edge with flap) should point towards the wedge.

NOTE: Ensure the envelope is centered, *not angled*, on the center guide. If the position of the envelope is incorrect, the separator gap adjustment will be incorrect.

2. Push up and release the blue wedge locking lever.
3. Slide the wedge toward the envelope, until the top edge of the envelope fits into the center slot of the wedge.

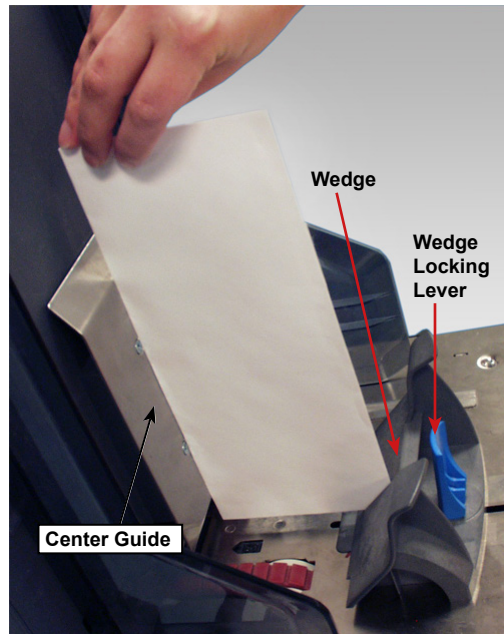

4. Push down on the trail prop locking lever to lock the wedge into place and remove the envelope.

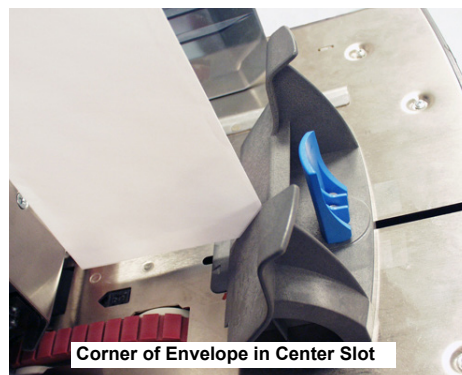

Adjust the HCEF Separator Gap

NOTE: Adjust the HCEF Wedge before you can adjust the Separator Gap..

1. Prepare an envelope for the separator gap adjustment:
 - a. Cut a strip of 20 lb. (80 gsm) paper to fit inside an envelope.
 - b. Insert the strip of paper into the envelope.

NOTE: Tap the envelope lightly against a hard surface to ensure the strip of paper rests all the way down at the bottom of the envelope.
 - c. Close the envelope flap.
2. Push up on the separator gap lever to raise the separator.

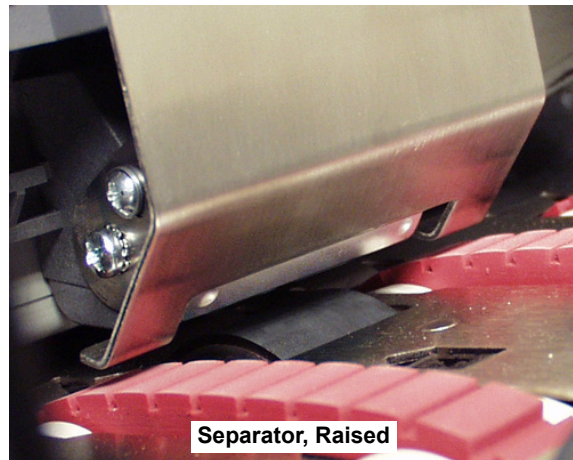

3. Place the envelope, bottom edge first, into the separator so the top edge (flap crease) lines up with the edge of the tab on the Wedge.

NOTE: The edge of the tab is indicated by two arrows.
4. Lower the separator completely, then push down on the separator gap lever to lock it into place.

- Pull the envelope out from the HCEF.

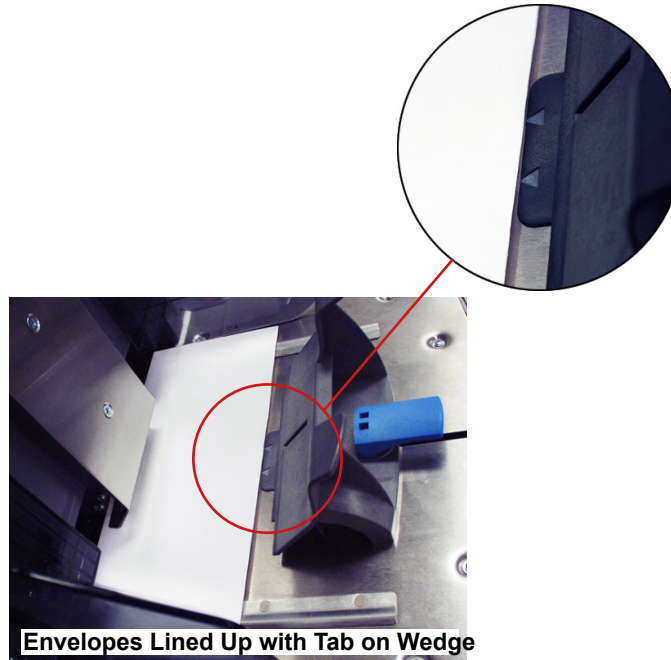

- Shingle a .7 to 2-inch (20mm to 50mm) stack of envelopes.
- Place the envelopes into the HCEF flap side down, flap last.
- Finish loading a full stack of envelopes (up to 500 pieces), making sure that the envelopes contact the back of the side guides. It is not necessary to shingle the remaining envelopes.

NOTES:

- If an HCSF or attached printer is present, you may need to adjust guides to ensure sheets feed correctly.
- If you are using scanning, you may need to adjust the scan head to ensure the bar code or OMR mark is read.

Additional Adjustments

Once you have loaded the items for the selected job, you may need to make some envelope opener adjustments to ensure job accuracy.

The envelope openers in the insertion area open each envelope to allow insertion of the contents. If you are using a different size envelope than the previous job, you need to confirm that the envelope aligns properly with the openers before running the new job. Follow the steps in the next section to verify envelope alignment and to make adjustments.

Pre-Run Adjustments

Feed a Test Envelope

1. Load the outer envelopes into the envelope feeder(s).
2. From the Home screen select **Loading Instructions> Pre-Run Adjustments> Envelope Opener Settings**.

NOTE: The system automatically selects the feeder when only one outer envelope is being used. If multiple outer envelopes are to be used, you need to select an envelope feeder.

3. Press **TRIAL PIECE** to feed one envelope to the insertion area.
4. Open the insertion area cover and observe the envelope. If you need to make adjustments, follow the procedures for setting the width and/or length, as stated next.



Perform Width Adjustments (Outer Envelope Openers)

1. Loosen the thumbscrews on the top of the outer envelope openers.

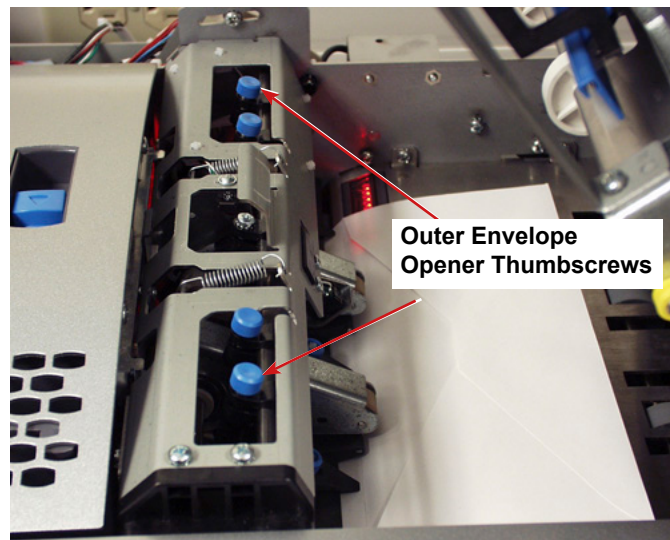

2. Slide the openers as required to align the pointers with the outer edges of the envelope.
 - Push down on the thumbscrews to ensure the outer envelope openers align with the envelope.
 - If using small envelopes (less than 7.5 inches / 194mm wide), move the outer envelope openers out and away from the outer edges of the envelope.
 - If using windowed envelopes, ensure the outer envelope openers do not touch the edges of the window.

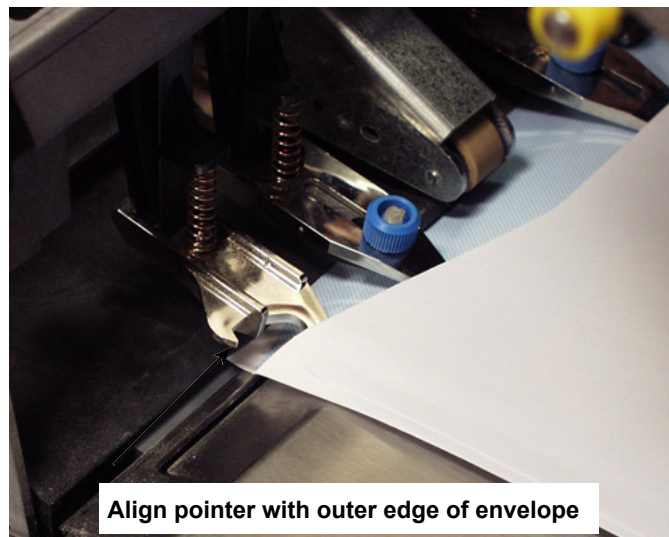

3. Tighten the thumbscrew on the top of the outer envelope openers.

Perform Length Adjustments (Inner Envelope Openers)

1. If using windowed envelopes, loosen the thumbscrews that secure each inner envelope opener.

NOTE: There are three inner envelope openers and these typically need length adjustments only. When needed, these (except the Middle Opener) can be moved laterally.

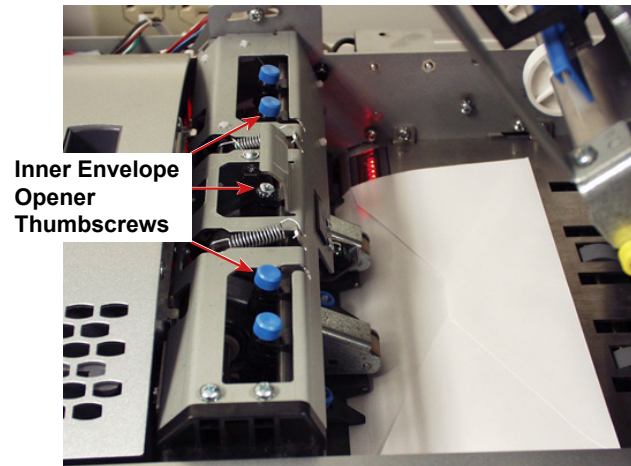

- a. Position the inner envelope openers so they do not touch the edge of the window. In unusual circumstances, (i.e., vertical windows, you may need to place the opener on the window to prevent the opener from catching on the window's edge).
 - b. Tighten the thumbscrews for the adjusted openers.
2. Press down and pull one of the knobs on the top of the frame to determine how far the insertion edge of one inner envelope opener goes into the envelope.

3. If necessary, loosen the knob on the insertion edge of the inner envelope opener, and adjust until it goes *at least* 5 mm into the top panel of the envelope.

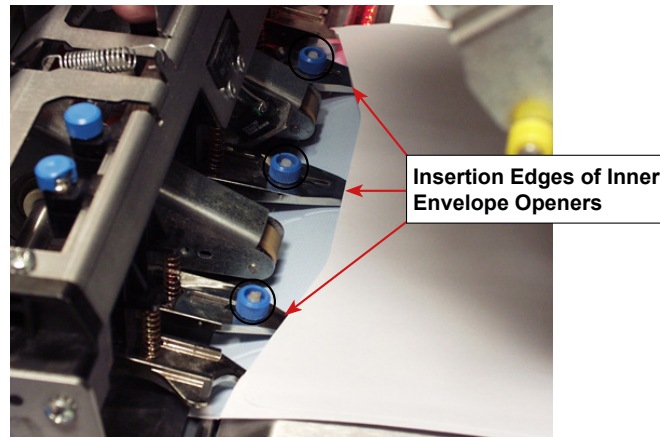

4. Tighten the knob for the adjusted insertion edge.
5. Repeat steps #2 - 4 for the other two insertion edges

Verify Settings

When you finish making the necessary envelope opener adjustments, close the insertion area cover, then verify your settings by doing the following:

1. Press **CLEAR DECK**.
2. Press **TRIAL PIECE**.
 - If the envelope openers are positioned correctly (aligned correctly to open the envelope), select **OK**
 - If more adjustments are needed, repeat the steps stated in the previous sections until proper alignment is achieved.

NOTE: Each time **TRIAL PIECE** is pressed, a trial piece is generated.

Manual Feeder

The system automatically adjusts for most materials. However, if the throats of your outer envelopes vary significantly, a manual adjustment may be needed. Likewise, if different width or length sheets are fed from a HCSF (High Capacity Sheet Feeder), there are adjustments to be made.

Use the manual feeder to hand feed stapled or unstapled sets of up to five sheets. The inserter waits for each set to be manually fed before folding and inserting the set into the envelope.

NOTES:

- The feeder type of the item (to be fed manually) in the current job has to be defined as manual for the feature to work.
- The job with the manual fed piece can also include items from other feeders, including sheets or inserts.

To use the manual feeder for a job:

1. Push the **Manual Feed** lever up.
2. Press **TRIAL PIECE** to start the inserter.
3. Feed each set by pushing the edge into the rollers one at a time.
4. Push the lever down when you are done.



Adjust Manual Lever for Stiff Media Mode (FPi 8100 Only)

Mail pieces with stiff inserts leave the inserter through the flats exit. The Stiff Media feature requires the manual lever (with sensor) to hold the flats gate open. This hardware is included with FPi 8100 inserters.

When one or more inserts have been designated “stiff”, the job requires an envelope of length 6 inches (152 mm) to 7 inches (178 mm) and that the manual lever be placed in the flats position.

- Envelopes must be fed from the feeder tower; the HCEF cannot be used.
- Mail piece components may be too short to leave the inserter through the flats exit when they are not in an envelope.
- **CLEAR DECK** does not function in stiff media mode. You must clear the inserter manually.

To adjust the manual lever for stiff media mode:

1. Open the sealer cover.
2. Adjust the lever to the stiff media position.
3. Close the sealer cover.

Run a Trial Piece

When job setup is completed, you must run a trial piece to ensure system function and verify the accuracy of the final mail piece. To run a trial piece:

1. Attach the feeder trays to the feeder tower.

NOTE: Highlight the Mail Piece Tree Icons on the Home screen for information on the tray type to use, orientation of the material in the tray, and location of the tray on the feeder tower.

2. Load the mail piece components into the feeder trays.
3. Press **TRIAL PIECE**. The system collates all contents of the mail piece according to the job parameters. The mail piece is fed to the upper divert area waiting for inspection. It does not go through the sealer. The Trial Piece Complete screen displays.
4. Examine the mail piece:
 - a. Remove the contents from the outer envelope.
 - b. Be sure the items are collated in the proper order and the destination address displays correctly, in the case of a windowed enveloped.
 - c. Check for doubles.
5. Depending on your findings, choose one of the following options:
 - a. If the trial mail piece passes inspection, select **Trial Piece OK** to return to the Home screen, *or* press **START** to begin the job.
 - b. If the address needs to be moved UP/DOWN (applies to Windowed envelopes), select **Adjust Address**. The following screen appears.

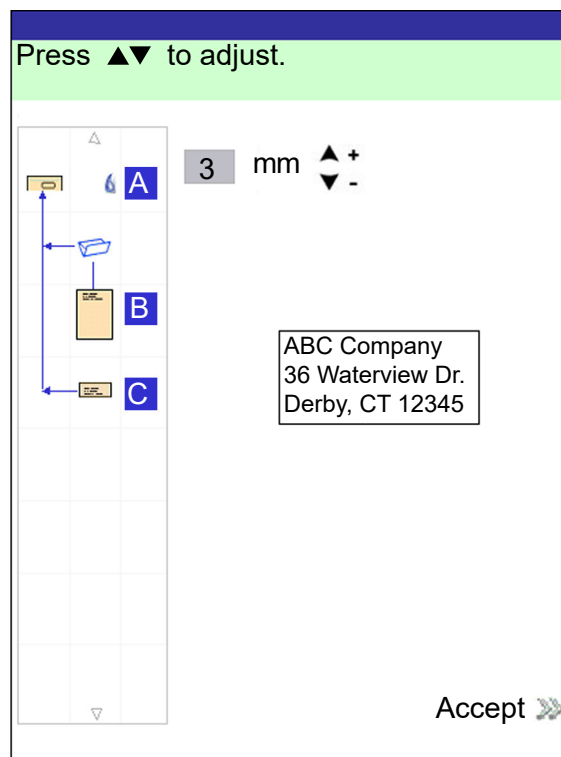

- c. Use the UP/DOWN keys to re-position the address, and then select Finished. You will be returned to the Home screen.
- d. If you want to make other adjustments, select **Edit Job**. You will now be able to add, delete, or move mail piece components and to change parameters for a document(s) in the mail piece.

NOTES:

- If you make any changes to the mail piece order, address position and/or to a document(s) in the mail piece, run Trial Piece again to verify inserter function and mail piece accuracy.
 - Any edits you make are NOT saved unless a Supervisor/Manager specifically saves them.
- e. If you need to check/verify the job settings, access the Review Job screen (select **Home>Menu>Jobs>Review Job**).

Review Job Settings

The Review Job screen provides an at-a-glance view of the settings for each of the mail piece component parameters and the general job settings. This screen is a time efficient way to make sure that you have selected the correct job.

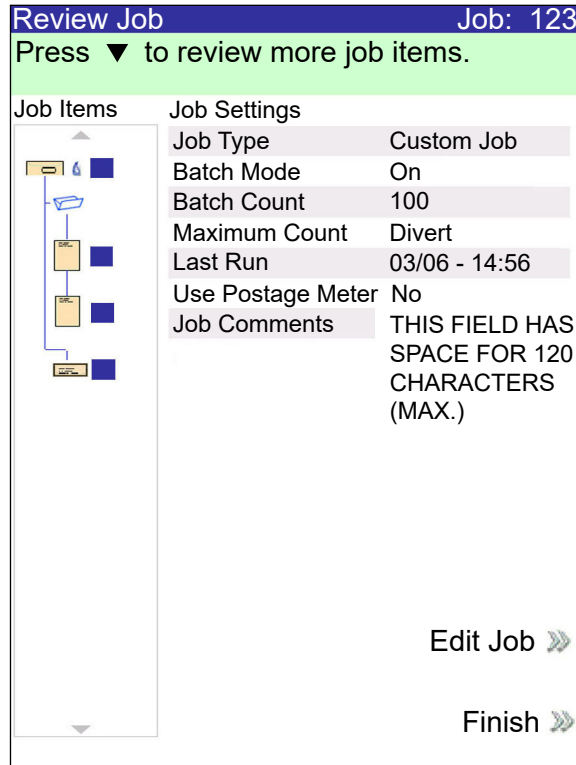

Review Job Screen

To access the Review Job screen:

1. At the Home screen, select **Menu**.
2. At the menu screen, select **Jobs>Review Current Job**.
3. Use the arrow keys to scroll through the settings for the job and each of the included items.
 - Select **Edit Job** to access screens for making changes.
 - Select **Finish** to return to the Menu screen.
 - Press **HOME** to return to the Home screen.

NOTE: Make sure that the materials in the mail piece meet material specifications. Refer to the *Specifications* section of this guide.

Start the Job

Once the trial piece is verified, you are ready to start running the job:

1. Verify you are in the Home screen.
2. Press **START**. The system begins running the job

SwiftStart™ Jobs

SwiftStart™ mode allows you to run a simple job without entering any setup information. In SwiftStart™ mode, the system automatically senses the material and sets the required parameters for running the job. A SwiftStart™ job can be run without saving the settings, or a Supervisor/Manager can name and save the job for future recall and use.

To use SwiftStart™:

1. Select **SwiftStart** from the Home screen.
2. Attach and load Feeder Trays:
 - a. Load the outer envelopes in insert tray (A) or in the HCEF (G, if present on system).
 - b. Load sheets and then inserts, starting with the feeder farthest to the left and on the bottom.
 - c. Load the remaining sheets and/or inserts clockwise and to the right of the first item.
3. Press **TRIAL PIECE**.
 - The system feeds one envelope from the insert tray or HCEF (if present), and measures its length.
 - Then it feeds a sheet from the sheet tray and measures its length.
 - The system does some internal calculations with these measurements to determine the fold type for the control document.
 - Then the system repeats the measuring and fold determination procedure for each sheet and insert, creating a Mail Piece Icon Tree in the process to represent this job.
 - When all items from loaded trays/feeders have been fed, the system produces a sample mail piece.
4. Check the trial piece, and then make any needed adjustments.
5. Repeat the trial piece process until the mail piece meets your specifications.
6. Press **START** to run the job.
7. To save this job you need supervisor or manager access to enter a name in the save job screen. *(Refer to the FPI 5100/6100/7100/8100 Series Admin Guide for more details on how to save a job.)*

Running the Mail Machine Interface

Follow the steps below to process mail using the MMI.

1. Power-up the inserting system.
2. Power-up the mailing system.
3. Ensure that the inserting system has been set up for the job:
 - Job loaded (be sure the **Use Postage Meter** option is set to **On**.)
 - The material must be loaded.
 - A trial piece must be run successfully.
4. Ensure that the mailing system has been set up to process mail:
 - Class set
 - Rate/weight set
 - Mode set (if appropriate)
 - Select Account (if applicable)
5. Adjust the side guide to the width of an envelope that will be used.
(Refer to the following images for requirements.)

NOTE: The MMI does not support flats.

6. Verify the following:

- Sufficient funds for the job on the mailing system
- MMI is working
- Correct mode is set on the mailing system



Side Guide (without MMI)

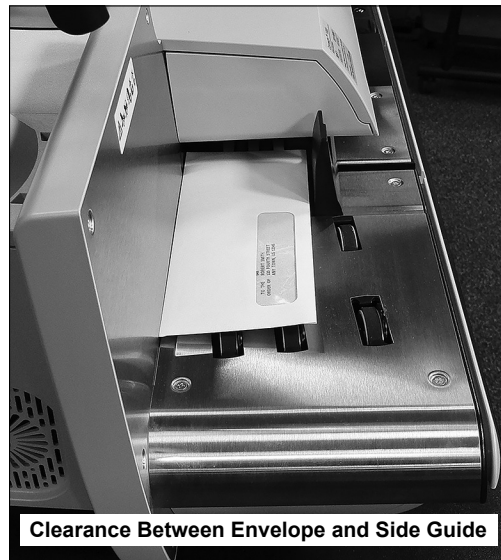

7. Press the **Start** button on the inserter.

- The inserter begins assembling mail pieces, which the mailing system accepts and processes.
- The mailing system sends the inserter a message for each exiting piece of mail.

Adjust Screen Brightness and Contrast

Follow the steps below to adjust the contrast and/or brightness of the display screen:

1. From the Home screen, select **Menu>Tools>Configure System>Set Brightness/Contrast**.
2. From the Set Brightness/Contrast screen:
 - Press the UP/DOWN arrow key(s) to increase/decrease screen brightness.
 - Press the LEFT/RIGHT arrow key(s) to decrease/increase screen contrast.
 - To return to the default settings, select **Restore Defaults**.
3. When you are done:
 - Press **Finished** to back through the configure system screens and return to the Home screen. Your settings will be saved.

OR

 - Press **HOME** to save your adjustments and return to the Home screen.

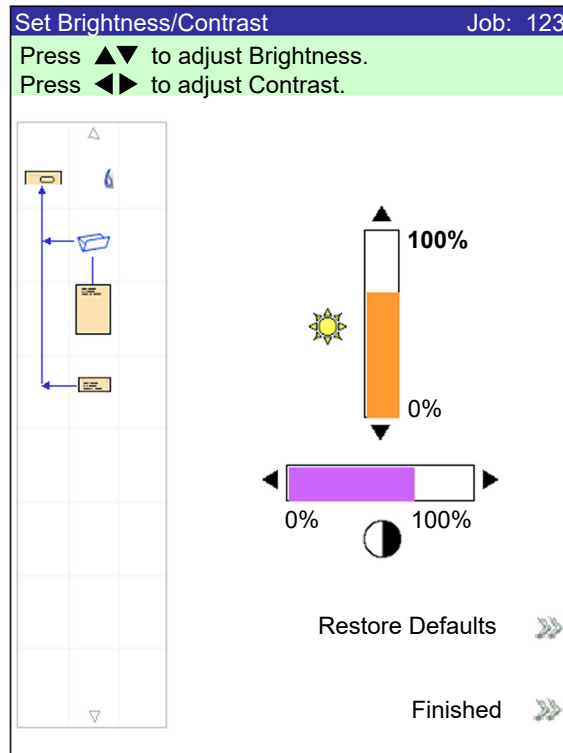

Set the Time and/or Date

Follow the steps below to adjust the internal Time and/or Date of the system:

1. From the Home screen,
select **Menu>Tools>Configure System>Set Date/Time**.

NOTE: If you are not logged in with supervisor or manager access rights, you will be prompted to enter an access code.

2. Press the LEFT/RIGHT arrow key(s) to select the item you want to change, (i.e., Month, Day, Year, Hour, or Minute). The items highlight as you press the LEFT/RIGHT arrow key(s).
3. Press the UP/DOWN arrow key(s) to select the desired number.
4. When you are done:
 - Press **Finished** to back through the configure system screens to the Home screen. Your settings will be saved.
 - OR*
 - Press **HOME** to save your adjustments and return directly to the Home screen.

Set Time/Date

Press ◀▶ to select.
 Press ▲▼ to adjust.

Month	Day	Year	Hour	Minute				
7	/	22	/	2006	-	23	:	54

Finished >>>

Refill the Sealing Solution

A warning message appears on the display screen when it is time to replenish sealing solution in the sealer bottle :

To refill the bottle:

1. Open the Sealer bottle cover and remove the bottle from its holder on the system and place it on a flat surface.
2. Unscrew the pressure-sensitive top and remove it from the bottle.
3. Pour sealing solution into the bottle until it reaches the fill line.

NOTE: Water is an acceptable liquid to use in the Sealer, but is not recommended. The use of water can result in bacterial growth that can inhibit the performance of the sealer.

4. Screw the pressure-sensitive top securely back onto the bottle.
5. Wipe off any excess fluid that may have spilled.
6. Put the bottle back into the holder and close the Sealer cover.

NOTE: First time use of the sealing system, as well as situations in which the wick has become dry, will require a brief waiting period to allow the wick to get moist.

This page is intentionally blank.

4. Scanning

Contents

Scanning Overview.....	4-3
1D Scanning Overview (includes OMR).....	4-3
2D Data Matrix Scanning Overview.....	4-5
Physical Specifications - 2D Data Matrix Barcodes.....	4-6
Printing Specifications - 2D Data Matrix Barcodes.....	4-7
Clear Zone Requirements	4-10
Recommended Barcode Content	4-11
Adjusting the Scan Heads	4-12
Adjusting Scan Heads for Ladder or 2D Orientation Marks ...	4-12
Additional Information.....	4-17



This page is intentionally blank.

Scanning Overview

The HiCap Sheet Feeder (HCSF) on the tower of the FPi 5100 - 8100 inserter can scan both OMR, 1D (code 3 of 9, interleaved, 2 of 5) and 2D data matrix barcodes. A 1D scanner or a 2D camera can be present on either side of the HCSF. The tower supports 1D ladder scanning on either side or a 2D camera only on the left side.

1D Scanning Overview (includes OMR)

The system offers two types of scanning; both types are optional features:

- **Optical Mark Recognition (OMR)** - uses a dark solid line on a sheet of light colored paper. OMR presents in a "ladder" orientation.
- **Barcode Recognition (BCR)** - a series of vertical bars and spaces presented in "ladder" or "picket" orientation. Barcodes that can be used with your system are 1D (code 3 of 9, interleaved 2 of 5) and 2D data matrix.



Direction of Feed: ↑ or ↓

Example: "Ladder" Orientation (OMR and BCR Marks)

NOTE: A HCSF is required to scan barcodes in **picket** orientation. Picket orientation uses a moving beam scanner. A moving beam scanner or a 2D camera can be present on either side of the HCSF.

Direction of Feed: ↑ or ↓



Example: "Ladder" Orientation (OMR and BCR Marks)

FPI OMR Mark Specifications at a Glance			
Description	Metric	Inches	Closest Fraction
Minimum line width for OMR or barcode marks	10 mm	0.40"	7/16 inch
Minimum spacing between OMR marks	2.5 mm	0.10"	1/10 inch
Maximum spacing between OMR marks	4.5 mm	0.18"	3/16 inch
Minimum space between mark clear zone and paper edge	11 mm	0.42"	7/16 inch
Minimum clear zone on side of marks	3 mm	0.12"	1/8 inch
Minimum clear zone on top of marks	9 mm	0.38"	3/8 inch
Distance from top sheet to first mark	20 mm	0.79"	3/4 inch
Distance from bottom of sheet to last mark	20 mm*	0.79"	3/4 inch
Maximum length of code	89 mm	3.50"	3-1/2 inch

2D Data Matrix Scanning Overview

2D data matrix barcodes provide a compact barcode option to keep the physical size of the barcode to a minimum. This makes it easier to fit a barcode into a document.

2D data matrix barcodes can store a large amount of data in a smaller sized barcode. They can store more data than standard linear barcodes (such as code 3 of 9).

The data capacity of a 2D data matrix barcode is determined by two factors:

- The **dimension** of the barcode measured by the number of modules. A module is either a black or white square.

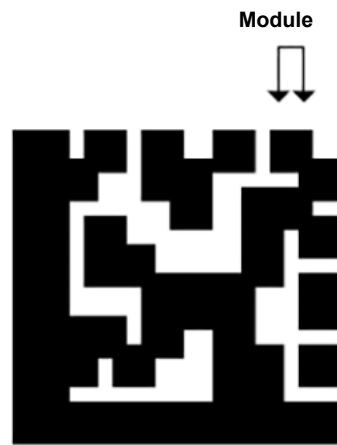

- The **data encoding method** used when the barcode is generated. The three most common data encoding types are:
 - Numeric (just numbers, highest data density)
 - Alphanumeric (numbers and letters)
 - Binary (just numbers 0 and 1)

Customers may encode their barcodes in any of these three formats. For inserters, the number of characters encoded in the barcode is critical, not the encoding type.

NOTE: Customers should supply samples of their raw barcode data so we can determine if we can support their application.

Physical Specifications - 2D Data Matrix Barcodes

These are the 2D data matrix barcode physical dimensions supported by the FPi 5100 - 8100 inserters.

- Rectangle 2D barcodes are only supported in the High Capacity Sheet Feeder (HCSF).
- Square 2D barcodes are supported in both the HCSF and tower.

Barcode Specifications - HCSF

Item	Minimum	Maximum
# of characters	1	32*
Symbol width	3.3 mm (0.125")	15.875 mm (0.625")
Symbol length	3.3 mm (0.125")	19.05 mm (0.75")
Module size	0.33 mm (0.013")	0.635 mm (0.025")
# of modules (square)	10 x 10	32 x 32
# of modules (rectangle)	8 x 18	16 x 48

*Software ignores any data beyond the 32nd character

Barcode Specifications - Tower

Item	Minimum	Maximum
# of characters	1	32*
Symbol width	3.3 mm (0.125")	12.5 mm (0.492")
Module size	0.33 mm (0.013")	0.635 mm (0.025")
# of modules (square)	10 x 10	32 x 32

*Software ignores any data beyond the 32nd character

Printing Specifications - 2D Data Matrix Barcodes

- Codes must be printed with black ink on a white background (contrast must be greater than 75%)
- Code cannot be printed over any text or graphics
- Code should not intersect any perforation
- Printer should be set for printing at 600 DPI or higher
- Codes must be barcode quality grade of A (using ISO15415 standard barcode grader)

Supported Square Format

Square format is supported by the HCSF and the tower.

FPI 5100 - 8100 inserters support square 2D data matrix formats and these corresponding data capacities.

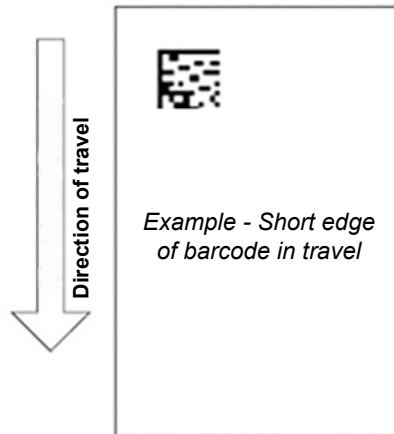

2D Square Format Data Capacities

Size	Maximum Numeric Capacity	Maximum Alpha-numeric Capacity	Maximum Binary Capacity	Minimum Supported Module Size (mm)	Maximum Supported Module Size (mm)
10 x 10	6	3	1	0.33	0.635
12 x 12	10	6	3	0.33	0.635
14 x 14	16	10	6	0.33	0.635
16 x 16	24	16	10	0.33	0.635
18 x 18	36*	25	16	0.33	0.635
20 x 20	44*	31	20	0.33	0.635
22 x 22	60*	43*	28	0.33	0.635
24 x 24	72*	52*	34*	0.33	0.635
26 x 26	88*	64*	42*	0.33	0.635
32 x 32	124*	91*	60*	0.33	0.635

*Can be read, but software ignores any data beyond the 32nd character

Supported Rectangular Formats

Rectangular 2D data matrix barcodes are only supported by the HCSF. They can be placed on the page in several orientations.

- Short Edge - short edge of barcode in the direction of travel
- Long Edge - long edge of barcode in the direction of travel

Short Edge

Short edge of the barcode goes first.

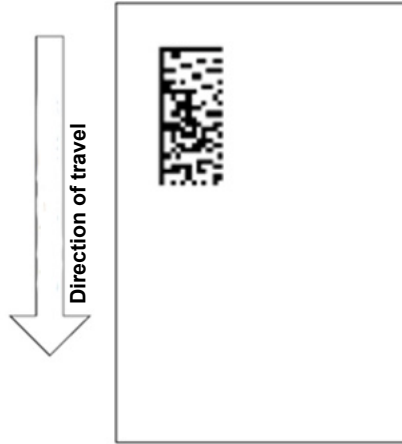

2D Rectangular Format Data Capacities - Short Edge

Size	Maximum Numeric Capacity	Maximum Alpha-numeric Capacity	Maximum Binary Capacity	Minimum Supported Module Size (mm)	Maximum Supported Module Size (mm)
8 x 18	10	6	3	0.33	0.635
8 x 32	20	13	8	0.33	0.5842
12 x 26	32	22	14	0.33	0.635
12 x 36	44*	231	20	0.33	0.4826
16 x 36	64*	46*	30	0.33	0.4826
16 x 48	98*	72*	47*	0.33	0.381

*Can be read, but software ignores any data beyond the 32nd character

Long Edge

Long edge of the barcode goes first.

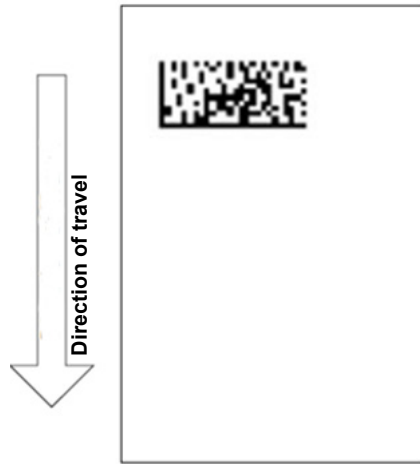

2D Rectangular Format Data Capacities - Long Edge

Size	Maximum Numeric Capacity	Maximum Alpha-numeric Capacity	Maximum Binary Capacity	Minimum Supported Module Size (mm)	Maximum Supported Module Size (mm)
8 x 18	10	6	3	0.33	0.635
8 x 32	20	13	8	0.33	0.453
12 x 26	32	22	14	0.33	0.559
12 x 36	44*	231	20	0.33	0.432
16 x 36	64*	46*	30	0.33	0.432
16 x 48	98*	72*	47*	0.33	0.330

*Can be read, but software ignores any data beyond the 32nd character

NOTE: There are some combinations that are not supported and result in a barcode length or width that exceeds 15.875 mm maximum length or width specification.

Clear Zone Requirements

The area around the barcode should be kept clear from print, etc. This area is called the clear zone. Keeping this area clear prevents print being read by the scanner in error.

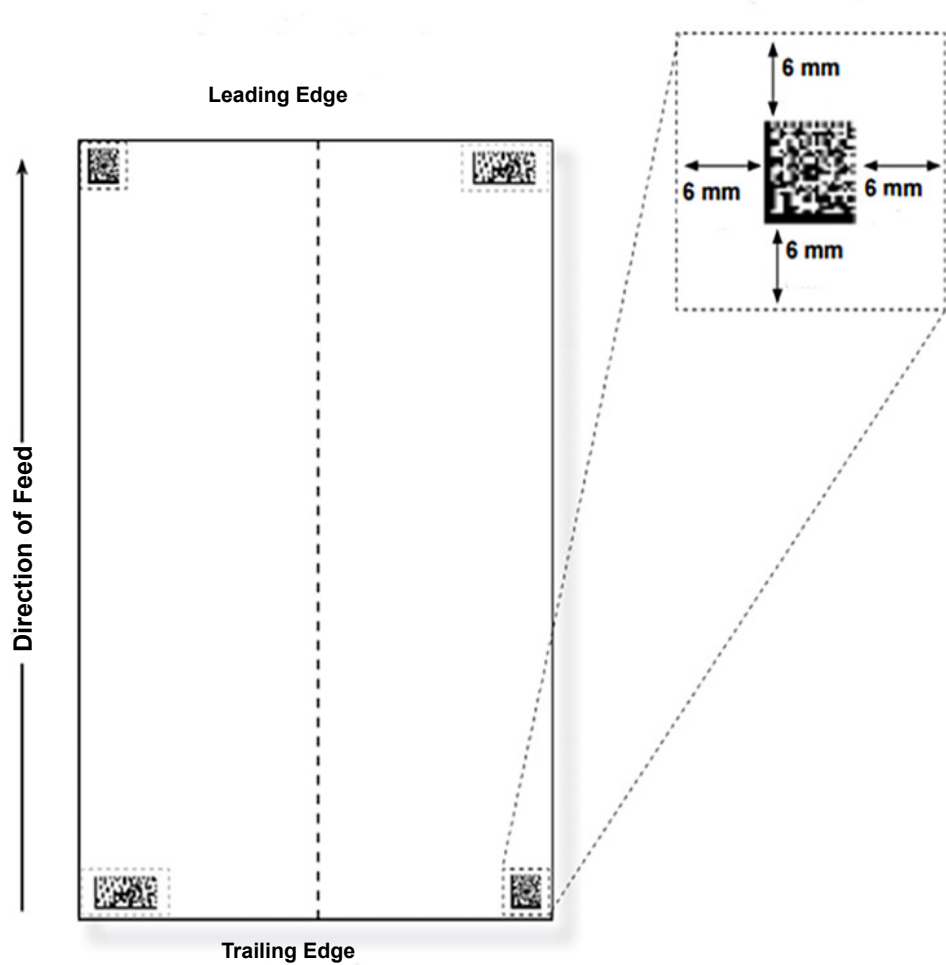

Recommended Barcode Content

Inserter Barcode Setup						
Function	Abbreviation	Character	Bits	Size	Options	Comment
					Code Type: Datamatrix First Page Only: No	
Job ID	JID	1	4	8	Controlling: No Coding Type: String Code Base: 32 LSB: Last	The Job ID is a string-based function and not a number-based function. It is typically a 6 or 8 digit number that remains constant throughout the job. When Trial Piece is pressed the Job ID is read from the first piece and then compared to the Job ID numbers of the rest of the run. If the job ID number changes within the same job, the system stops processing the material and displays a Job ID mismatch error.
Match Code	MC	9	4	6	Controlling: Yes Code Base: 10 Coding Type: CCD Wrap at: 999999 Include Zero: No Count Direction: Down LSB: Last	This function is used as the Piece ID in an open or closed loop control system in conjunction with an external host computer. In this case, the Match Code should be unique within the run.
Page Number	PN	15	4	2	Controlling: No Coding Type: CCD Count Direction: Down LSB: Last	This code represents the page number within the current collation.
Page Count	PC	17	4	2	Controlling: No Coding Type: CCD Code Base: 10 LSB: Last	Sets the number of documents fed per collation.
Client Use	CU	19	4	2	They are compacted bits and do not need to be set up. The inserter ignores.	These two characters are used for specific clients use, such as select feeds or edge marking.

Adjusting the Scan Heads

Once the system administrator or system supplier sets up the scan configuration, the key to maximizing barcode or OMR performance lies in proper adjustment/positioning of the scan heads to be able to read the mark.

The scan heads are located in the feeder tower or the HCSF (if present on your system.) There are two scan heads in either location. This allows the system to read the mark regardless of the mark's location on the sheet.

Additionally, more than one sheet within a set can be marked. If multiple sheets are using the same scan head, the marks on each sheet must be oriented so they pass over the scan head in the same position.

If both scan heads are used, they must be offset by at least 0.787" (20 mm) to avoid errors.

IMPORTANT: The side guides must be set properly in order for the scan heads to read the marks correctly. Additionally, material must be jogged back into place and loaded as an even stack to ensure the scan head and marks align properly. Refer to *Load Material into the Trays* for more information.

Adjusting Scan Heads for Ladder or 2D Orientation Marks

1. Fold one of the sheets to be scanned in half vertically (side with mark facing up.)
2. Draw two arrows, one at the top of the mark, and one at the bottom of the mark, pointing towards the top of the sheet.

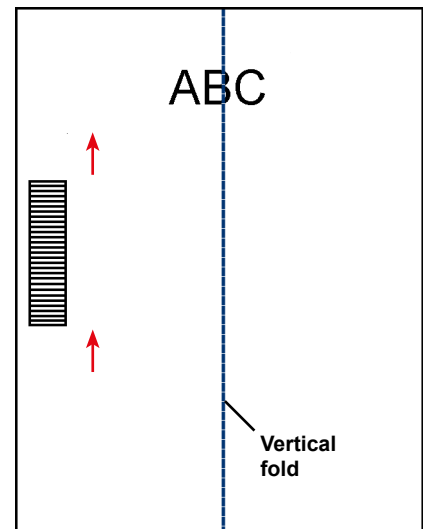

3. Fold the sheet horizontally, so the barcode appears on either side of the fold line.

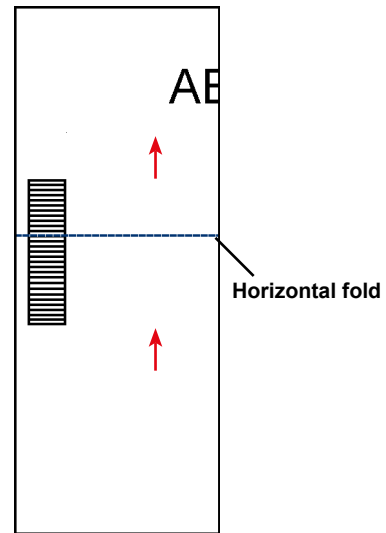

4. Open the main transport deck cover. Use the ruler to measure the distance from the center of the sheet (lined up at 0 on the ruler) to the center of the marks.
5. Refer to the loading instructions to determine:
 - Scan head location for this sheet (left or right)
 - If the sheet will be loaded top or bottom first
6. Open the tower cover:
 - If the scanner is in the Feeder Tower (Feeders A, B, C, D) open the feeder tower cover
 - If the scanner is in the HCSF (High Capacity Sheet Feeder J, K, L, M), open the HCSF tower cover.

TIPS:

- Remove the left feeder trays from the feeder tower to allow the HCSF tower cover to open freely.
 - If you have two HCSFs on your system, the first HCSF Tower will prevent the second tower (farthest) from opening fully. For best results, be sure you have proper lighting when adjusting the scan head in the second tower.
7. Determine the direction the scan head needs to be moved (to the left or right of 0 on the ruler):
 - Make sure the center of the sheet (the vertical fold) is lined up with the center of the inserter (at 0 on the ruler.)
 - If the sheet is loaded top first, make sure the arrows point DOWN.
 - If the sheet is loaded bottom first, make sure the arrows point UP.

8. Determine the direction the scan head needs to be moved (to the left or right of 0 on the ruler):
 - Make sure the center of the sheet (the vertical fold) is lined up with the center of the inserter (at 0 on the ruler.)
 - If the sheet is loaded top first, make sure the arrows point DOWN.
 - If the sheet is loaded bottom first, make sure the arrows point UP.
9. Use the blue thumbwheel to move the scan head. Move the thumbwheel until the pointer lines up with the measurement (distance from the center of the page to the center of the mark) defined earlier.

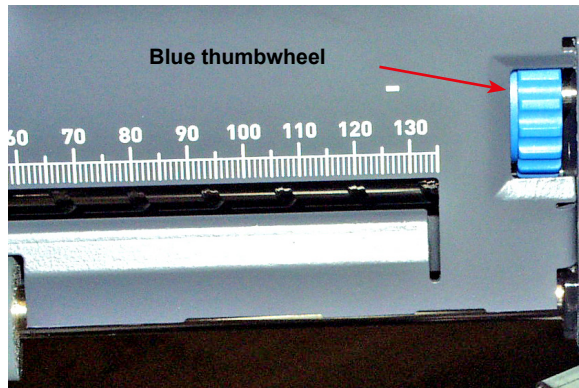

Blue Thumbwheel - Adjust Scan Head Position

NOTE: The scanning area on your system may appear different, but operation concepts are the same.

Move thumbwheel until pointer lines up with distance measure

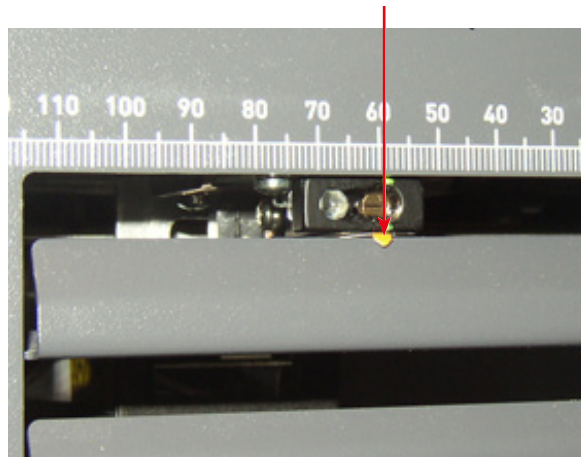

Pointer Ensures Correct Scan Head Position

NOTE: The scanning area on your system may appear different, but operation concepts are the same.

10. If additional scan heads are to be used, repeat step 1 to 8 for each.
11. To verify the adjustment is correct:
 - a. From the home screen, select **Loading Instructions and Pre-Run Adjustments>Scanner Setup**.
 - b. Use the UP/DOWN arrow keys to select a feeder to run.
 - c. Press **TRIAL PIECE** to feed a piece from the highlighted feeder.
 - d. Select **Finish**.

Adjusting the Scan Heads for Picket Orientation Marks

1. Fold one of the sheets to be scanned in half vertically (side with mark facing up.)
2. Draw two arrows, one at the top of the mark, and one at the bottom of the mark, pointing towards the top of the sheet.

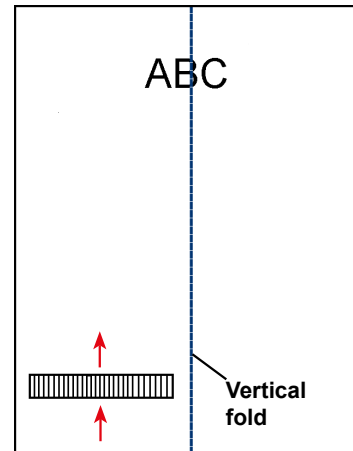

3. Fold the sheet horizontally, so the barcode appears on either side of the fold line.
4. Open the main transport deck cover. Use the ruler to measure the distance from the center of the sheet (lined up at 0 on the ruler) to the center of the marks.
5. Refer to the loading instructions to determine:
 - Scan head location for this sheet (left or right)
 - If the sheet will be loaded top or bottom first.
6. Open the HCSF Tower cover.

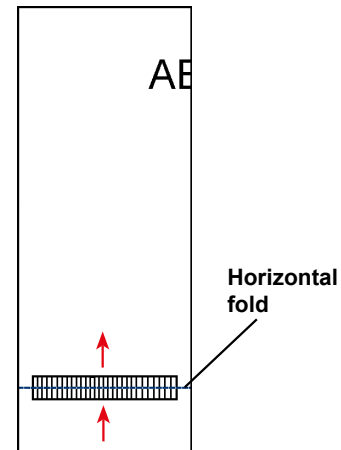

TIPS:

- Remove the left feeder trays from the feeder tower to allow the HCSF tower cover to open freely.
- If you have two HCSFs on your system, the first HCSF tower will prevent the second tower (farthest) from opening fully. For best results, be sure you have proper lighting when adjusting the scan head in the second tower.

7. Determine the direction the scan head needs to be moved (to the left or right of 0 on the ruler):
 - Make sure the center of the sheet (the vertical fold) is lined up with the center of the inserter (at 0 on the ruler.)
 - If the sheet is loaded top first, make sure the arrows point DOWN.
 - If the sheet is loaded bottom first, make sure the arrows point UP.
8. Use the blue thumbwheel to move the scan head.

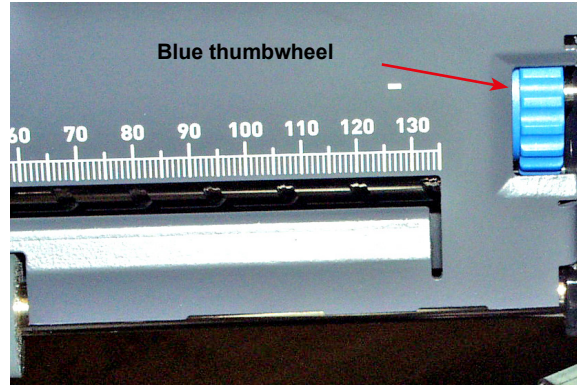

Use Blue Thumbwheel to Adjust Scan Head Position

NOTE: The scanning area on your system may appear different, but operation concepts are the same.

9. Move the thumbwheel until the pointer lines up with the measurement (distance from center of page to center of the mark) defined earlier.

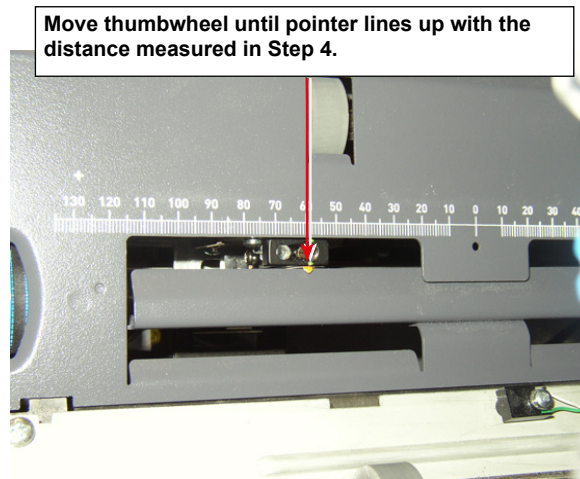

Use Pointer to Ensure Correct Scan Head Position

10. If additional scan heads are to be used, repeat step #1 - 8 for each.

Additional Information

- Paper weight range for OMR is 18 lb. (70 gsm) to 32 lb. (120 gsm).
- Feeder linking will only work correctly if the operator has started with the correct sheet (i.e. linking can only be done reliably on a collation break). The feed order and print order determines if feeder linking is possible. Some sort of collation integrity (WAS or MC) ensures right pieces are in the right collations.
- Selective feed of additional sheets is always available up to the maximum limits of either folder (8 sheets of 80 gsm paper or equivalent) or 25 sheets into a flat envelope.



This page is intentionally blank.

5. *Stoppages and Troubleshooting*

Contents

Clear Material Stoppages.....	5-3
Clear a Stoppage.....	5-3
Resume the Job	5-3
Outsorted Material	5-4
Troubleshooting and Self-Help Aides	5-4



This page is intentionally blank.

Clear Material Stoppages

If a material stoppage occurs, the system immediately stops the job and displays an error message.

Follow the instructions on the display screen (removing material that caused the stoppage, resuming the run, and handling the outsorts) to get your system running again.

Clear a Stoppage

The procedure for clearing a stoppage varies and depends on the area where the stoppage occurs.

Follow these guidelines to clear most material stoppages:

1. Use the error message information on the display screen to locate the problem area.
2. Open any covers necessary to allow to the material stoppage.
3. Clear only the area indicated.
4. If prompted to clear deck, press **CLEAR DECK**.
5. Follow the instructions on the display screen to clear the stoppage.
6. Once the stoppage is cleared, close any open cover(s).

The error message clear sand the Home screen displays.

Resume the Job

To resume running a job after a stoppage is cleared:

1. Verify there are no error messages on the screen and that all system covers are closed.
2. Press **START**.
 - If the error message on the screen instructed you to remove material in trays to start a new collation, pressing **START** will begin a new collation, *otherwise*
 - The job will resume counting from the last complete mail piece that it produced.

Outsorted Material

During the recovery from jams and other machine stoppages, the system will automatically clear material from the transport deck that cannot be completed by the inserter.

The system counts all mail pieces that it has successfully completed (trial pieces included), but partially assembled pieces are not counted and are transported to the upper divert area. The system handles outsorts by:

- Discard the items
- Manually assemble the piece

Troubleshooting and Self-Help Aides

The system generates an error message when a problem occurs. The message identifies the error and possibly the cause of it. Suggestions on fixing the problem also displays.

- In addition to these messages, use the tables included here to help identify problems and corrective action(s).
- You also can press **HELP** on the control panel to access a Help file to view information on system functions and procedures.
- If you cannot resolve your problem using these self-help aides, call your system supplier.

Table 5-1 Startup Problems

Problem	Cause	Action
System won't power up	System power cord is not plugged into the wall outlet.	Plug power cord into wall outlet.
	No power at outlet.	Check outlet. Verify that wall outlet has power.
	Faulty Power Supply, circuit board wiring, or Power Switch.	Call your system supplier.

Table 5-2 Control Panel Problems

Problem	Cause	Action
<ul style="list-style-type: none"> No display; but system power is on. (LED in upper right corner of the Control Panel is orange or green.) Display locks up. Screen Option Keys don't work. Machine Keys don't work. 	Faulty circuit boards or power supply, loose wiring, or poor connections.	Press the power button to restart system. If problems persist, call your system supplier.
	Display timeout.	Press the OK key turn on the display.
Display is too light or dark (contrast and/or readability problem).	Poor contrast / brightness adjustment.	Adjust contrast and/or brightness settings.

Table 5-3 Tower Feeder Problems

Problem	Cause	Action
Failure to feed.	Material not within specifications.	Check that all material meets published specifications. Refer to <i>Feeder Tower Material Specifications</i> for more information. <ul style="list-style-type: none"> Remove curled or warped material. Use only material that has been stored properly. NOTE: High humidity can make paper limp and cause curling. Additionally, recycled material can sometimes be problematic.
	Improper loading.	<ul style="list-style-type: none"> Be sure to fan (aerate) material before loading. Be sure to follow the loading instructions as suggested on the display screen. Check side guides. NOTE: Guides set tightly up against stack can disrupt or prevent material from feeding. <ul style="list-style-type: none"> Check that material is loaded in the correct feeder and in the proper orientation.
	Paper fragments or debris in tray, rollers or tower transport.	Inspect feed rollers and transport path. Remove paper fragments before running a clear deck.
Double or multiple feeds; stream feeding.	Material not within specifications.	Check that all material meets published specifications. Refer to <i>Feeder Tower Material Specifications</i> for more information. NOTE: Some glossy materials contain contaminants that can clog feed rollers and cause stream or double feeds.
	Improper loading.	Be sure to fan (aerate) material before loading, especially material that has been printed recently. NOTE: Low humidity can cause paper to accumulate a static charge and cling together.
	Dirty, worn or glazed feed and/or retard rollers.	Clean or replace affected rollers. Contact your system supplier.

Table 5-3 Tower Feeder Problems, <i>continued</i>		
Problem	Cause	Action
System incorrectly detects double feeds.	Double detect is seeing flap or seam of insert envelope	<ul style="list-style-type: none"> Set the custom double detect window where there is no flap, seam or window on the envelope. <p>OR</p> <ul style="list-style-type: none"> Turn double detect off. <p>Refer to the <i>Insert Options</i> section of this guide for more information.</p>
	Sheets or inserts have: <ul style="list-style-type: none"> Thick printed black text, Images, or Thick print on both sides. 	Set the custom double detect window in an area that does not have thick printing, then run the trial piece again. Refer to <i>Sheet Options</i> or <i>Insert Options</i> and <i>Running a Trial Piece</i> for more information. If the problem persists, turn double detect off.
	Tray is feeding a mix of different thickness sheets paper (e.g. some 20 lb. and 24 lb. sheets mixed.)	<ul style="list-style-type: none"> If the material is consistently a certain weight (i.e. printer was initially loaded with 20 lb. / 80gsm) paper then accidentally loaded with 24 lb / 90gsm.) then rerun the trial piece. <p>Refer to <i>Running a Trial Piece</i> or more information.</p> <p>OR</p> <ul style="list-style-type: none"> Turn off double detect. <p>Refer to <i>Sheet Options</i> for more information.</p>
First piece following trial piece is a false double.	The initial trial piece was likely a real double.	Run the trial piece again. Refer to <i>Running a Trial Piece</i> for more information.

Table 5-4 Tower Area Problems		
Problem	Cause	Action
Stoppage in tower area.	Material not within specifications, causing skew.	Check that all material meets published specifications. Refer to <i>Feeder Tower Material Specifications</i> for more information. <ul style="list-style-type: none"> Remove curled or warped material. Use only material that has been stored properly. NOTE: High humidity can make paper limp and cause curling. Additionally, recycled material can sometimes be problematic.
	Improper loading: material skew caused by Tower feeders.	Check side guide adjustment on trays. Skewed material is a common cause of problems in the tower area. Refer to <i>Adjust Tray Side Guides</i> for instructions.
	Paper fragments or other obstruction in transport.	Inspect. Clean.
	Flexible plastic material guides in tower area are broken or displaced.	Open tower cover and inspect. If replacement is necessary, call your system supplier.

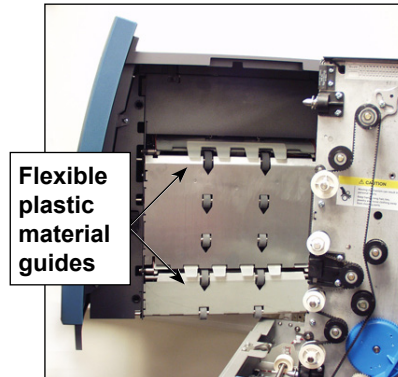

Table 5-5 Folder/Inverter Problems		
Problem	Cause	Action
Stoppage in folder.	Paper fragments.	<ul style="list-style-type: none"> Open folder and check for obstruction. Remove paper fragments/residues.
Stoppage in inverter.	Material not within specifications.	Check that material meets specifications. NOTE: Sets that use the inverter cannot be wider than 9 inches (225mm).

Table 5-6 Insertion Area/Envelope Flapper Area Problems

Problem	Cause	Action																																									
Stoppage in insertion area or flapper area; failure to insert.	Outer envelope is skewed.	Check side guides; incorrect adjustment can cause skewing. Refer to <i>Adjusting Tray Side Guide</i> for instructions.																																									
	Envelope openers improperly adjusted.	Perform setup adjustment. Refer to <i>Adjusting the Envelope Openers</i> for instructions. The standard insertion finger configuration is five fingers (three inner envelope openers and two outer envelope openers). The alternative configuration is three fingers (three inner envelope openers). To obtain the alternative configuration, slide the fingers outside the envelope. If the envelope is too wide to have the fingers completely outside the envelope, take the lower part of the fingers off.																																									
<table border="1"> <thead> <tr> <th>Envelope Size</th> <th>Fulls Size Booklet</th> <th>Sheets</th> <th>Insert/Small Booklet</th> <th>Recommended Finger Setting</th> </tr> </thead> <tbody> <tr> <td rowspan="6">Flat</td> <td>No</td> <td>Yes</td> <td>Yes</td> <td>3</td> </tr> <tr> <td>Yes</td> <td>Yes</td> <td>No</td> <td>3</td> </tr> <tr> <td>Yes</td> <td>Yes</td> <td>Yes</td> <td>3</td> </tr> <tr> <td>Yes</td> <td>No</td> <td>No</td> <td>3</td> </tr> <tr> <td>Yes</td> <td>No</td> <td>Yes</td> <td>3</td> </tr> <tr> <td>No</td> <td>Yes</td> <td>No</td> <td>5</td> </tr> <tr> <td rowspan="2">Letter, DL, 6x9 and C5</td> <td>n/a</td> <td>Yes</td> <td>No</td> <td>5</td> </tr> <tr> <td>na</td> <td>Yes</td> <td>Yes</td> <td>5*</td> </tr> </tbody> </table>					Envelope Size	Fulls Size Booklet	Sheets	Insert/Small Booklet	Recommended Finger Setting	Flat	No	Yes	Yes	3	Yes	Yes	No	3	Yes	Yes	Yes	3	Yes	No	No	3	Yes	No	Yes	3	No	Yes	No	5	Letter, DL, 6x9 and C5	n/a	Yes	No	5	na	Yes	Yes	5*
Envelope Size	Fulls Size Booklet	Sheets	Insert/Small Booklet	Recommended Finger Setting																																							
Flat	No	Yes	Yes	3																																							
	Yes	Yes	No	3																																							
	Yes	Yes	Yes	3																																							
	Yes	No	No	3																																							
	Yes	No	Yes	3																																							
	No	Yes	No	5																																							
Letter, DL, 6x9 and C5	n/a	Yes	No	5																																							
	na	Yes	Yes	5*																																							
*3 fingers if collation is thicker than 4 mm.																																											
<div style="display: flex; justify-content: space-around;"> <div style="text-align: center;"> <p>Inner Envelope Openers</p> <p>Recommended 3 Finger Setting</p> </div> <div style="text-align: center;"> <p>Inner Envelope Openers</p> <p>Recommended 5 Finger Setting</p> </div> </div>																																											

Table 5-6 Insertion Area/Envelope Flapper Area Problems

Problem	Cause	Action
Stoppage in insertion area or flapper area; failure to insert. (continued)	Envelope opens improperly adjusted. (continued)	 <p>Recommended distance: .5-inch to 1 inch (15 to 25mm) between the tip of the outside finger and the edge of the envelope.</p>
<p>Large booklet: Binding must be parallel to the feed direction; most likely booklets that are inserted in flat envelopes that are close to the size of a full sheet.</p>  <p style="text-align: center;">Binding parallel to feed direction</p> <p>Small booklet: Binding must be perpendicular to the feed direction; most likely booklets that are inserted in C5 or 6x9 envelopes.</p>  <p style="text-align: center;">Binding perpendicular to feed direction</p> <p>Refer to <i>Adjusting the Envelope Openers</i> for setup adjustment instructions.</p>		
Insufficient edge clearance.		Check clearance: envelope width must be <i>at least</i> .5-inch (13mm) greater than the sum of the width of the widest insert <i>plus</i> the insert pack thickness. NOTE: For the special case of a single piece into a standard business envelope, 9 mm clearance is sufficient.
	Insertion pack or envelopes not centered	Ensure that Side Guides are set correctly. Too much clearance between Side Guides and material can cause material to become skewed in machine. Refer to <i>Adjusting Tray Side Guides</i> for instructions.

Table 5-6 Insertion Area/Envelope Flapper Area Problems, continued

Problem	Cause	Action
	<ul style="list-style-type: none"> • Contents of insertion pack are catching on side seam inside of envelope. • Contents of insertion pack are thick and difficult to insert into smaller envelopes. 	<p>Adjust the Aligner custom settings:</p> <p>NOTE: If the contents of the insertion pack are thick, and you are having trouble inserting the pack into a small envelope, be sure to set the "Envelope Width" and "Widest Enclosure Width" to the exact dimensions of the insertion pack.</p> <ol style="list-style-type: none"> 1. From the Home screen, select "Menu", then "Jobs". 2. Select "Edit Current Job", "Edit Job Settings", "Advanced". 3. Select "Aligner", then "On with Custom Settings". The Customer Aligner Settings screen displays. 4. Select "Envelope Width". Use the UP/DOWN arrow keys to increase or decrease the measurement, as necessary. Select "Accept" when done. 5. Select "Widest Enclosure Width". Use the UP/DOWN arrow keys to increase or decrease the measurement, as necessary. Select "Accept" when done. 6. Select "Accept" on the Custom Aligner Settings screen once the necessary adjustments have been made

Table 5-7 Moistener/Mail Piece Exit Problems		
Problem	Cause	Action
No seal, failure to seal, incomplete seals.	Sealing is off in job set up.	<ul style="list-style-type: none"> Check job definition. Make sure sealer is ON.
	Low sealant level.	Add water or sealing solution.
	Poor quality envelopes.	Inspect envelopes. Examine glue lines.
	Worn moistener brushes.	Inspect. Replace if necessary. Refer to Replacing the Moistener Brushes for instructions.
	Worn moistener wick.	Inspect. Replace if necessary. Refer to Replacing the Moistener Wick for instructions.
High seal: flap is folded/sealed above crease line.	Outer envelope or content skew. <ul style="list-style-type: none"> Contents of insertion pack are catching on side seam inside of envelope. Contents of insertion pack are thick and difficult to insert into smaller envelopes. 	<ul style="list-style-type: none"> Check Side Guide adjustment. Check for proper loading of material in Trays. <p>Adjust the Aligner custom settings:</p> <p>NOTE: If the contents of the insertion pack are thick, and you are having trouble inserting the pack into a small envelope, be sure to set the "Envelope Width" and "Widest Enclosure Width" to the exact dimensions of the insertion pack.</p> <ol style="list-style-type: none"> From the Home screen, select Menu>Jobs. Select Edit Current Job>Edit Job Settings>Advanced.. Select Aligner>On with Custom Settings. The Customer Aligner Settings screen displays. Select Envelope Width. Use the UP/DOWN arrow keys to increase or decrease the measurement, as necessary. Select Accept. Select Widest Enclosure Width. Use the UP/DOWN arrow keys to increase or decrease the measurement, as necessary. Select Accept. Select Accept on the Custom Aligner Settings screen once the adjustments have been made.
	Poor quality envelopes.	Check side seam(s) inside of envelope for excessive stickiness. Glue residue inside of the envelope may prevent it from opening fully and easily.
Stoppage in envelope exit area.	Glue contamination or debris in transport.	Inspect and clean transport.
Box seal: material obstructs envelope fold, causing flat area at crease.	Materials are not inserted deep enough into envelope.	<p>Adjust the Envelope Crease Line upstream so materials are inserted deeper into the envelope:</p> <ol style="list-style-type: none"> From Home select Menu> Tools>Configure System>Set Envelope Crease. Select the appropriate envelope position. Press Finished three times to return to Home. <p>IMPORTANT: This is a system setting; it will be effective for all applications on the machine.</p>

Table 5-7 Moistener/Mail Piece Exit Problems, continued

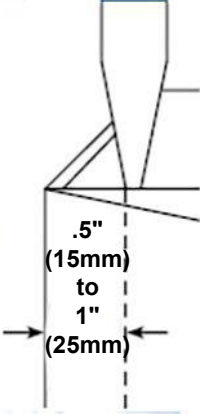
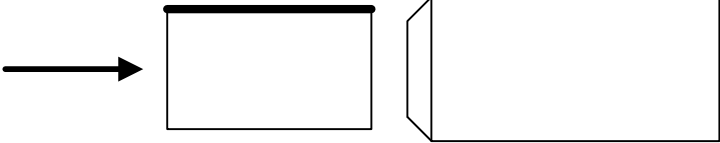
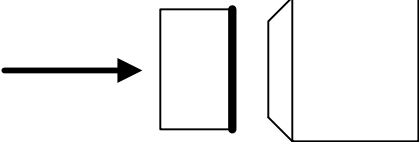
Problem	Cause	Action
Envelope exit through letter path is unreliable; envelope is damaged.	Collations may be too stiff to exit through the letter exit path.	<p>If the envelope is longer than 6 inches (152 mm), process it through the flat exit path:</p> <ol style="list-style-type: none"> 1. At the Home screen select: "Menu", then "Job". 2. Select Edit Current Job>Choose the Item to modify>Edit Highlighted Item>Additional Setting>Advanced>Stiff Media. 4. Select Yes. <p>NOTES:</p> <ul style="list-style-type: none"> • If the Stiff Media option is not available (grayed out), enable it in the system setting. • If the envelope is not a flat envelope, the system assigns the envelope to a Tower feeder even if a HCEF is installed on the machine.

Table 5-8 High Capacity Envelope Feeder Problems

Problem	Cause	Action
Failure to feed. OR Skew of envelopes.	Envelopes not advancing down Tail Prop.	Push or tap the bottom of the stack of envelopes to advance down tail prop.
	<ul style="list-style-type: none"> Separator Gap too tight. Side Guides too loose or too tight. Incorrect Tail Prop position. 	Check the separator gap, side guide, and tail prop settings. Refer to <i>Loading the HCEF</i> for instruction on the various setup adjustments.
	Debris in area below HCEF.	Remove debris.
Double feeds (envelopes fail to separate), stream feeds.	Separator Gap adjustment too wide.	Adjust the separator gap.
	Incorrect Tail Prop position.	Adjust the tail prop.
	Envelopes nested, stuck or glued together.	Remove unsatisfactory envelopes.
System incorrectly detects double feeds.	Double detect is seeing flap or seam of insert envelope	<ul style="list-style-type: none"> Set the custom double detect window where there is no flap, seam or window on the envelope. OR <ul style="list-style-type: none"> Turn double detect off.
First piece following trial piece is a false double.	The initial trial piece was likely a real double.	Run the trial piece again.
Envelopes stop in flapper. OR Envelopes stop in the transport beyond the flapper and are not flapped or partially flapped.	Incorrect loading of envelopes.	Ensure envelopes are properly oriented per the loading instructions on the display screen.
	Envelopes stuck or glued together.	Ensure envelope flaps are not bonded to the body of the envelope. Remove unsatisfactory envelopes.
	Side Guides set too loose or too tight.	Perform Side Guide adjustment.

Table 5-9 Mail Piece Problems		
Problem	Cause	Action
Wrong fold type.	Job is set up incorrectly.	Check job definition and make appropriate adjustments to meet job specifications.
Fold panel length incorrect.	Job is set up incorrectly.	Select auto-measure, or make manual adjustments to meet job specifications, then rerun a trial piece.
Address not showing in envelope window.	<ul style="list-style-type: none"> Item loaded incorrectly. Lead edge is not in the lead position. 	<ul style="list-style-type: none"> Reload item. Ensure lead edge is in correct position, as indicated in the loading instructions on the display screen. On Trial Piece Complete screen, press "Adjust Address" and follow the instruction that appear.
	Job is set up incorrectly.	Ensure the item with the address is personalized, and the correct address location is selected. Also, ensure the selected envelope type is "window" and the flap orientation is correct.

Table 5-10 Scanning Problems		
Problem	Cause	Action
<p>Two or more collations are inserted in a single envelope.</p> <p>OR</p> <p>A single collation is broken in two and inserted into two envelopes.</p> <p>OR</p> <p>System stops and declares an error.</p> <p>NOTE: Recommended OMR thickness is 0.012" (0.33 mm) to 0.49" (12 mm).</p>	Scanner head position improperly adjusted.	Check position adjustment of scanner head.
	Selected scan definition is incorrect for job.	Select correct scan definition.
	Scan definition set up incorrectly.	Review scan setup using scan setup options on the control panel.
	Material loaded in incorrect order.	Load material in correct order.
	Adverse paper motion. Refers to any misalignment of paper that can cause a misread. It includes paper skew, paper slippage and paper offset to one side of the transport.	Make sure material is properly loaded. In particular, check the feeder side guides. Check the transport is free of obstructions.
	Poor OMR / barcode printing. Problems include insufficient contrast, poor print quality (voids, fuzzy printing) and inadequate clear zones.	Check the mark specifications to make sure OMR or barcodes are fully compliant. Low toner in laser and dot matrix printers can cause problems, as can rough paper. Certain printing methods (such as ion deposition) can also cause printing problems.
	Scanner inoperative.	Contact your system supplier.



This page is intentionally blank.

6. *Maintenance*

Contents

Routine Maintenance.....	6-3
Daily Tasks	6-3
Replace the Moistener Wick.....	6-3
Replace the Moistener Brushes	6-5
Replace the Envelope Edge Marker Roller	6-6



This page is intentionally blank.

Routine Maintenance

There are several maintenance tasks operators can perform on the system. Be sure to schedule routine service with your system supplier at the appropriate intervals.

Daily Tasks

- Remove any excess paper dust that has accumulated on or around the system modules.
- Use a damp cloth to wipe unwanted soil marks from the covers.
- Report any system malfunctions and/or noticeable wear on system parts to your supervisor.

Replace the Moistener Wick

Replace the moistener wick when it becomes dry.

NOTE: Wear on the moistener wick and brushes begins to compromise seal quality at 250,000 machine cycles. It is recommended that you replace the wick and brushes at this time. Contact you system supplier to order supplies.

1. Open the insertion area cover.
2. Place some paper towels on the Sealer deck to the left of the reservoir. The towels will capture water that may drip from the old wick cartridge.

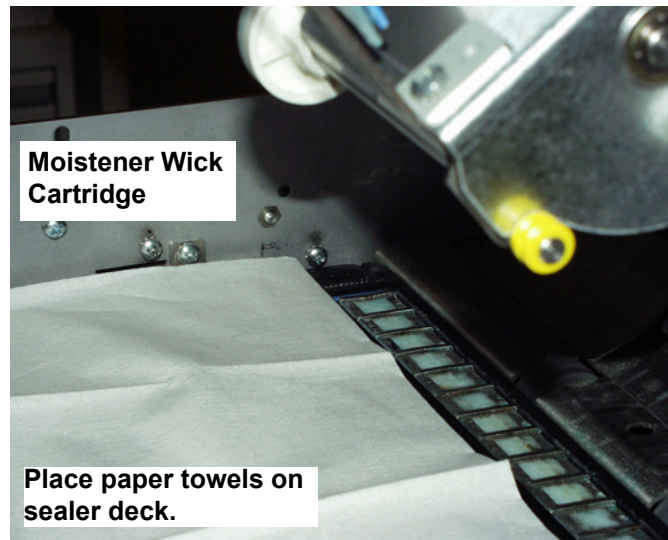

3. Release the plastic latches (one on each side of the reservoir):
 - a. Place the thumb of one hand on the latch at rear of machine (i.e. the latch furthest from you).

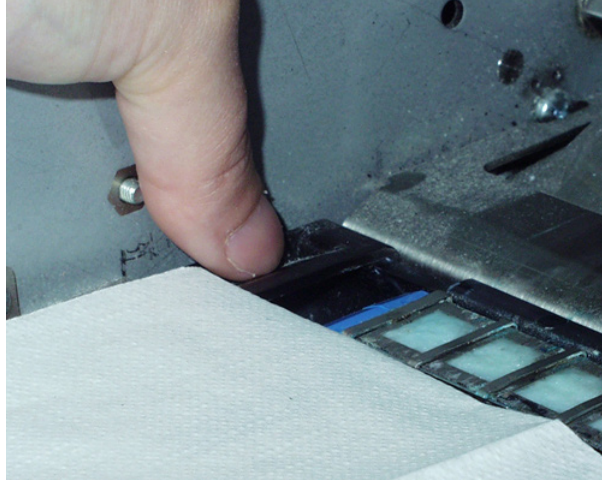

- b. Place index finger of the other hand on other latch (closest to you).
 - c. Slide the latches away from each other until both latches are free of the wick cartridge below them.
4. Pull the old wick cartridge straight up and out of the reservoir, and place it on the paper towels.

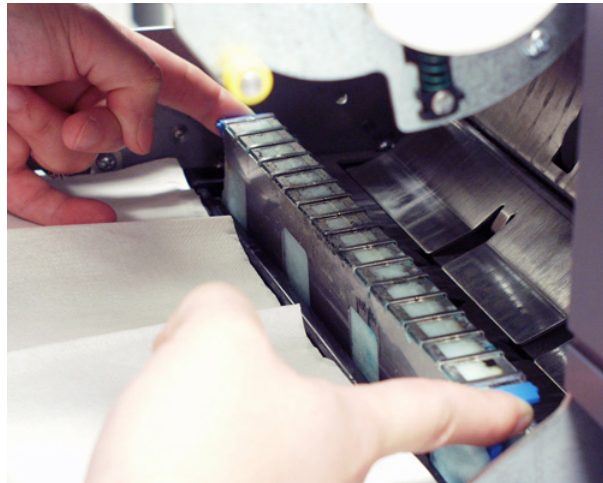

5. Wrap the paper towel around the old wick cartridge and discard.
6. Slide the new wick cartridge into the reservoir. Insert the cartridge with the open side of cartridge facing the exit end (rear) of machine.
7. Press down on the ends of the cartridge to make the two bump features of the cartridge sit below the top edges of the reservoir.
8. Slide the plastic latches toward each other and over the new wick cartridge until they snap into place.
9. Close the insertion area cover.

Replace the Moistener Brushes

Replace the moistener brushes when they show wear.

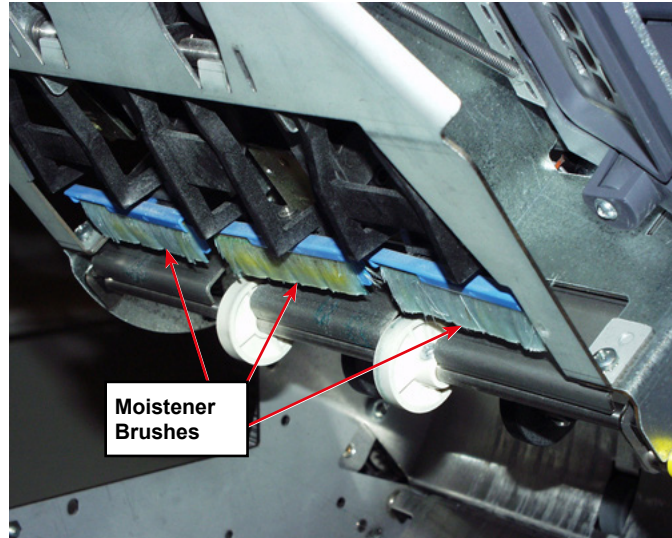

1. Open the insertion area cover.
2. Remove old brushes:
 - a. Hold the blue brush holder in place with one hand while you use the other hand to push the bristles of the old brush completely free from the holder.

NOTE: You will be pushing the bristles toward yourself.

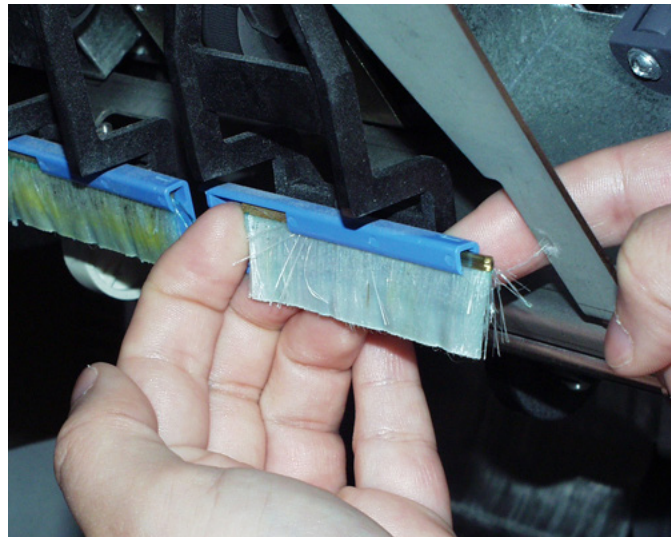

- b. Repeat for all three brushes and discard.

3. Install the new brushes:

NOTE: Avoid bending or deforming the brush bristles; permanent distortion of the bristles will prevent envelopes from sealing correctly.

- a. Hold the blue brush holder in place with one hand.
- b. Insert the metal edge of the new brush into the channel opening in front of the brush holder.
- c. Push the brush slightly into the brush holder channel to start it.
- d. Slide the new brush completely into the holder by its bristles until it stops.

NOTE: The brush is completely inserted when there is no more visible metal edge of the brush extending out from the front of the brush holder.

- e. Repeat for the remaining two brushes.

Replace the Envelope Edge Marker Roller

NOTE: Avoid touching the ink roller, as it is covered in ink.

1. Open the flats sealer cover.
2. Grasp the tab at the top of the old ink roller and lift to remove.
3. Grasp the tab at the top of the new ink roller and slide it onto the spindle.
4. Release the tab once the ink roller is seated firmly in place.
5. Close the flats sealer cover.

7. Specifications

Contents

System Specifications	7-3
System Footprint - Dimensions	7-3
Component Specifications.....	7-4
Component Dimensions	7-4
C omponent Capacities	7-4
Scanning Capability (optional).....	7-6
Environmental Limits	7-6
Feeder Tower and Base Material Specifications	7-7
General Information.....	7-7
Outer Envelopes.....	7-7
Inserts.....	7-10
Sheets	7-11
High Capacity Sheet Feeder (HCSF) Material Specifications ...	7-12
General Information.....	7-12
Sheets	7-12
Materials Not Certified for Use	7-13



This page is intentionally blank.

System Specifications

System Footprint - Dimensions

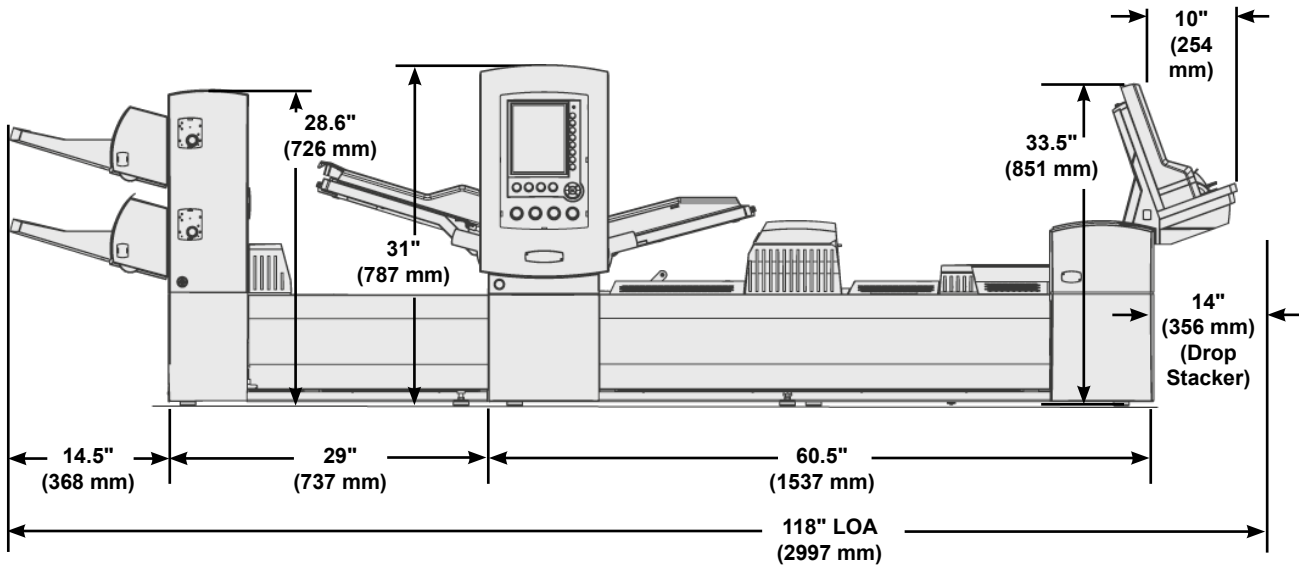
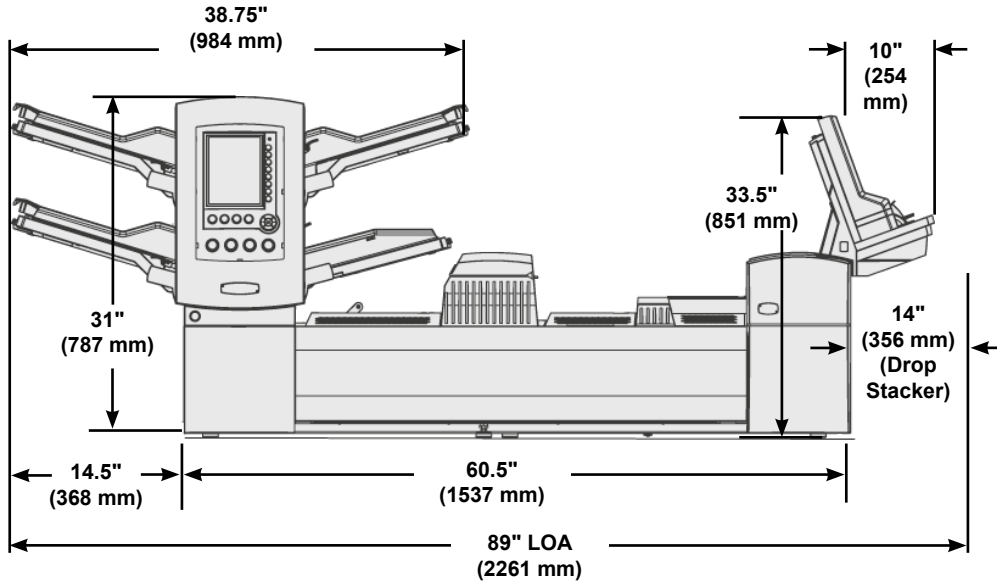

NOTES:

- System depth is 22.8" (579 mm)
- Drawings are not to scale
- All dimensions approximate
- The FPI 5100/6100 does not include the High Capacity Envelope Feeder

Component Specifications

Component Dimensions

	Length overall, height	Weight, unboxed
FPI 5100 Inserter	89" (2261 mm), 31" (787 mm)	327 lbs. (148 kg)
FPI 8100 Inserter	89" (2261 mm), 33.5" (851 mm)	350 lbs. (158 kg)
High Capacity Sheet Feeder (HCSF)	43.5" (1105 mm), 28.6" (726 mm)	150 lbs. (68 kg)
Vertical Power Stacker	17" (432 mm), 24" (610 mm)	21 lbs. (18.6 kg)
Exit Transport	20" (508 mm), 16" (406 mm)	52 lbs. (24 kg)
Flats Sealer	12.5" (317mm), 16" (406 mm)	82 lbs. (180.4 kg)

**All dimensions are approximate*

Component Capacities

Tower Sheet/Insert/Envelope Feeders	<ul style="list-style-type: none"> • 350 20 lb. (80 gsm) sheets; 350 insert cards; 250 envelopes • Feeders are multi-purpose: they can handle sheets, cards, slips and envelopes • Feeders, including envelope feeders, can be linked to increase running time • Feeders are available in pairs of two (maximum four feeders)
Folder	Up to 8 sheets of 20 lb. (80 gsm) material
Accumulator	Maximum collation thickness is 1/4" (6 mm)
High Capacity Sheet Feeder (HCSF)	Available in pairs. Capacity is 2,000 sheets per pair.
Drop Stacker	130 pieces, letter mail; 25 pieces, flat mail
Vertical Power Stacker	250 pieces, letter mail (assumes single sheet insert)
Production Power Stacker	At least one USPS mail tray (two feet of finished mail)
Moistener/Closer/Sealer	8,000 letters before refilling

Folder

Fold Types	Top address documents	C fold, Z fold, single and double fold	Maximum number of sheets per collation: 8 (20 lb. [80 gsm])
	Bottom address documents (see Notes below)	C fold, Z fold and single fold	
	Middle address documents (see Notes below)	C fold	
Machine Adjustments	None		
No-Fold (Bypass)	Yes		
Notes	<ul style="list-style-type: none"> Documents with addresses on the bottom <i>may</i> require the Inverter kit. Documents with an address present on the middle of the sheet <i>always</i> require the Inverter kit. Refer to the <i>Available Fold Type/Address Location/Envelope Type Combinations</i> table for more information. 		

Available Fold Type/Address Location/Envelope Type Combinations

Fold Type	Address Location	Envelope Type
C Fold	Top	Standard Flap
	Middle	Forward Flap
	Bottom	Bottom Flap
	Middle*	Standard Flap*
Z Fold	Top	Standard Flap
	Bottom	Bottom Flap
	Bottom*	Standard Flap*
Single Fold	Top	Standard Flap
	Top	Bottom Flap
	Bottom	Bottom Flap
	Bottom	Standard Flap
Double Fold	Top	Standard Flap
	Third Panel*	Standard Flap*

*Requires an inverter

High Capacity Envelope Feeder (HCEF)

The HCEF is standard on the FPi 7100/8100 professional series; it is not available for the FPi 5100/6100 series.

Material	Letter-size envelopes
Material Dimensions	Depth: 3.5" (89 mm) to 6.5" (165 mm) Width: 8.5" (216 mm) to 10.5" (266 mm)
Capacity	500 letter-sized pieces, 24 lb. (90 gsm) weight.

Scanning Capability (optional)

The system base module and the HCSF have an optional scanning capability for reading ladder format OMR and barcode marks. The HCSF has an optional scanning capability for reading picket format barcodes or 2D barcodes. The scanner kits are installed in the field.

OMR Codes Supported	5-Series, 3-Series, SECAP™ 2600, Francotyp-Postalia Console.
OMR Functions Supported	Variable page documents; selective feeding; feeder-to-feeder matching; force divert; mark for special handling.
Barcode Formats Supported	Code 39™ (3 of 9); Interleaved 2 of 5, 2D Datamatrix barcode.
Notes:	<ul style="list-style-type: none"> The horizontal position of the scanner is operator adjustable. Documents from any feeder can be scanned. Documents should be printed on a laser printer for scanning. Photo copied documents and documents printed on an ink jet printers may need the barcode to be increased in size to allow proper scanning of the barcode. All 2D barcodes need to be a grade A barcode.

Environmental Limits

	Temperature F (C)		Humidity %		Wet Bulb Temp. F (C)
	Minimum	Maximum	Minimum	Maximum	Maximum
Normal Operating Conditions	60 (16)	75 (24)	30	60	N/A
Extended Operating Conditions	50 (10)	95 (35)	08	85	85 (29)
Storage Conditions	15 (-09)	120 (49)	05	95	85 (29)
Shipping Conditions	-40 (-40)	140 (60)	05	100	85 (29)

Feeder Tower and Base Material Specifications

For reliable operation, all materials must conform to published specifications. Feed problems and high stall rates are often due to use of substandard materials.

General Information

- Material fed for letter-size mail pieces must be capable of being transported through a 1.5 inch (38 mm) radius, 1/4 turn without permanent deformation, breaking of perforations, or any other damage to the mail piece.
- Color Restriction: none for pre-printed material.
- Minimum Paper Opacity: 5% less than 16 lb bond (60 gsm) copy paper
- Maximum Paper Opacity (when double detection is required): 5% greater than 24 lb. bond (90 gsm) copy paper with normal 10 point printing throughout the page.

NOTE: Any substance added to improve material handling (such as powder) shall not fall off in visible quantities when the sheet is tapped on the edge of a hard surface.

Outer Envelopes

Envelope Construction and Material

- Envelopes shall be standard side seam, diagonal side seam, center seam, or executive. They can be die or web cut, with or without patched windows.
NOTE: Unpatched (open) window outer envelopes are not permitted.
- Window patches shall be flat, ripple free and made of glassine or polystyrene material. Patches shall be glued within 0.06 inch (1.6 mm) from the top edge of the patch material to the window cutout.
- Envelope materials shall include new or recycled white wove, manila, and lithographic material. Non-woven or synthetic envelopes or envelopes with external fasteners are not permitted.
- Envelopes with re-moistenable flap adhesives made of starch (dextrin), resin (tropical formulation) or combination of the two may be used.
- Outer envelope using self-seal, peel and stick, or pressure seal flaps are not permitted.
- The distance between the glue line and the bottom flap edge of the envelope shall not exceed 0.08 inch (2 mm).

Envelope Throat Definitions

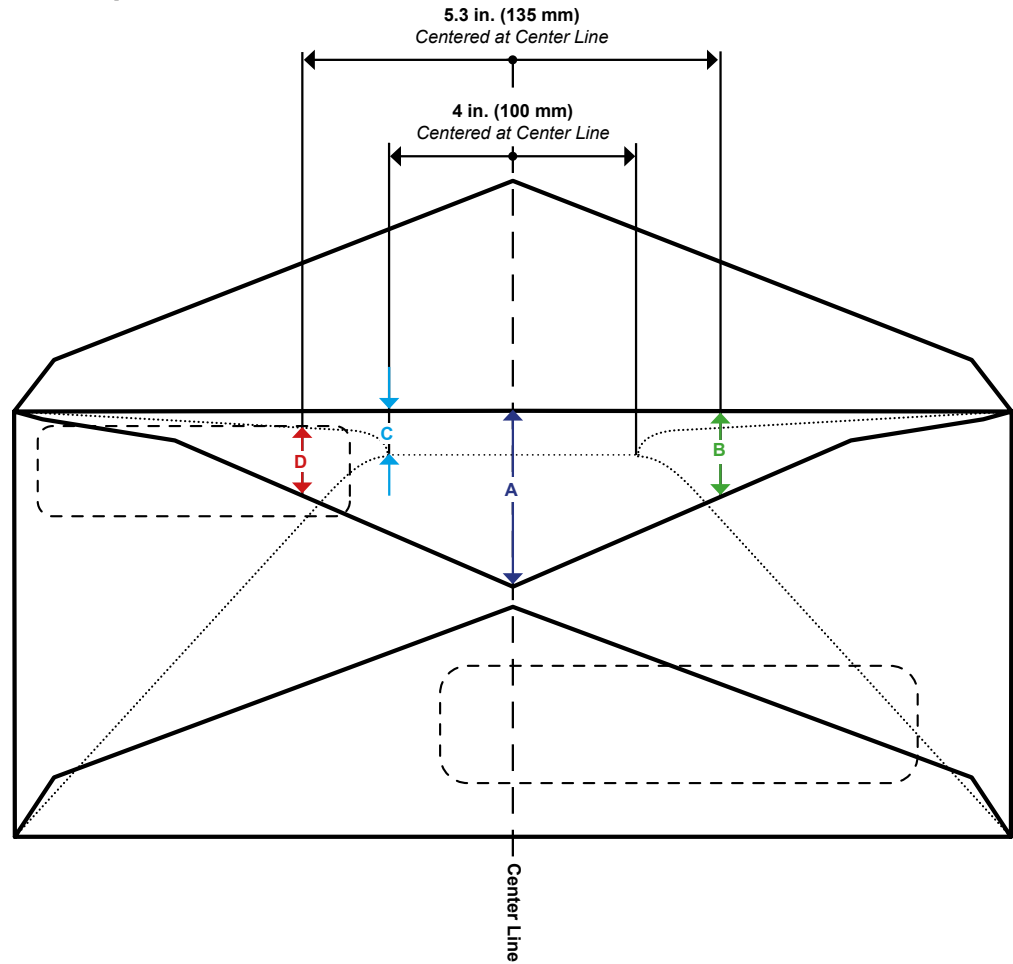

*Diagram is not to scale

Dimension	Value	Description
A	1.6 inch (41 mm)	Maximum throat depth measured at the center line of executive style envelopes.
B	1.4 inch (38 mm)	Maximum throat depth measured at a distance of 5.3 inches (135 mm) centered at the center line.
C	.25 inch (6 mm)	Minimum throat depth within a 4 inch (102 mm) area centered at the center line.
D	.08 inch (2 mm)	Minimum distance from top of window to the envelope throat measured at a distance of 5.3 inches (135 mm) centered at the center line.

Envelope Size for Insertion

- Envelopes shall be at least 0.5 inch (13 mm) wider than the sum of the maximum width of the insert pack plus the thickness of the pack.
- Envelopes shall be at least 1/4 inch (6 mm) deeper than material to be inserted.
- No more than three letter-sized sheets can be inserted into a #9 (C5) envelope when the aligner is in use.

Envelope Curl/Warp

- An envelope placed flap up on a flat surface under its own weight shall have no corner raised more than 0.5 inch (13 mm) from the surface.
- Curl/Warp of the envelope flap shall not exceed 1/8 inch (3 mm) measured while holding flap on flat surface at the crease line.

Letter-Sized Envelope Specifications

Parameter	Minimum Value	Maximum Value
Width	Feeder Tower: 6.37" (162 mm) HCEF: 8.9" (225 mm)	Feeder Tower: 10.5" (266 mm) HCEF: 10.4" (264 mm)
Depth	Feeder Tower: 3.5" (89 mm) HCEF: 3.9" (98 mm)	6.5" (165 mm)
Throat Depth*	0.25" (6.35 mm)	1.49" (38 mm), executive 1.61" (41 mm)
Paper Weight	18 lb. (70 gsm)	24 lb. (90 gsm)
Flap Depth	1.2" (30 mm)	2.5" (63 mm) within +/- 1/4" (35 mm) of Center 1.85" (47 mm) outside +/- 1.4" (35 mm) off center

*See *Envelope Throat Definitions* in this chapter for more information.

Feeder Tower - Flat-Sized Envelope Specifications

Parameter	Minimum Value	Maximum Value
Width	6.37" (162 mm)	10.5" (266 mm)
Depth	6.5" (165 mm)	13" (330 mm)
Throat Depth	0.25" (6.35 mm)	1.49" (38 mm)
Paper Weight	20 lb. (80 gsm)	24 lb. (90 gsm)
Flap Depth	1.2" (30 mm)	2.5" (63 mm)

Inserts

Inserts are defined as material that does not require folding (may be pre-folded) before insertion into letter-sized envelopes. This definition includes individual sheets, collations of unfastened sheets, C folded or single folded inserts or pre-made, bound booklets (no fastener exposed that might damage rollers).

Additionally, "insert" also refers to a single reply envelope (BRE) when inserted into a flat-sized envelope.

Material Substrates

- Acceptable paper types include - new or recycled bond, text, laser and offset. Offset coatings include matte, dull or gloss.
- Grain - material may be short or long grain.
- Printing - printing may be simplex (one side) or duplex (both sides) with no restriction on color.
- Coating - varnish applied to sheets to modify finish is allowed.

NOTE: Use of glossy material may degrade system performance.

Feeder Tower Inserts

Parameter	Minimum Value	Maximum Value
Width	5 inches (127 mm)	9.84 inches (250 mm)
Length	2.83 inches (72 mm)	6 inches (153 mm)
Thickness	0.003 inches (.076 mm)	0.1 inches (2.54 mm)
Paper Weight	16 lb. (60 gsm)	44 lb. (175 gsm)

Sheets

Sheets refer to material that must be folded before being inserted into standard letter envelopes. In the special case of flats, sheets are not folded. A group of sheets is referred to as a collation.

Material Substrates

Acceptable paper types include new or recycled bond, text, laser and offset. Offset coatings including matte, dull or gloss.

- Acceptable paper types include - new or recycled bond, text, laser and offset. Offset coatings include matte, dull or gloss.
- Grain - material may be short or long grain.
- Printing - printing may be simplex (one side) or duplex (both sides) with no restriction on color.
- Coating - varnish applied to sheets to modify finish is allowed.
- Laser printed material - freshly laser printed material that meets curl requirements is acceptable

NOTE: Use of glossy material may degrade system performance.

Feeder Tower Sheets

Parameter	Minimum Value	Maximum Value
Width	5 inches (127 mm)	9.84 inches (250 mm)
Length	5.31 inches (135 mm)	14 inches (356 mm)
Thickness	0.003 inches (0.076 mm)	0.012 inches (0.305 mm)
Paper Weight	16 lb. (60 gsm)	44 lb. (175 gsm)

High Capacity Sheet Feeder (HCSF) Material Specifications

For reliable operation, all materials must conform to published specifications. Feed problems and high stall rates are often due to use of substandard materials.

General Information

- Material fed for letter-size mail pieces must be capable of being transported through a 1.5 inch (38 mm) radius, 1/4 turn without permanent deformation, breaking of perforations, or any other damage to the mail piece.
- Color Restriction: none for pre-printed material.

Sheets

Sheets refer to material that must be folded before being inserted into standard letter envelopes. In the special case of flats, sheets may not be folded. A group of sheets is referred to as a collation.

Material Substrates

- Acceptable paper types include - new or recycled bond, text, laser and offset. Offset coatings include matte, dull or gloss.
- Grain - material may be short or long grain.
- Printing - printing may be simplex (one side) or duplex (both sides) with no restriction on color.
- Coating - varnish applied to sheets to modify finish is allowed.
- Laser printed material - freshly laser printed material that meets curl requirements is acceptable

NOTE: Use of glossy material may degrade system performance.

HCSF Sheets

Parameter	Minimum Value	Maximum Value
Width	7.99 inches (203 mm)	8.5 inches (216 mm)
Length	9.15 inches (232mm)	11.69 inches (297 mm)
Basic Weight	20 lb. (80 gsm)	24 lb. (90 gsm)

Notes:

- All sheets within a collation shall be within 0.37" (10 mm) of each other in length
- Maximum material thickness for feeders: 0.007" (0.18 mm) when scanning, otherwise 0.25 mm (0.009")

Materials Not Certified for Use

Contaminants

Materials with visible material loss (loose powder, ink, surface glaze, etc.) when hung free over a clean surface and struck sharply with a standard wood ruler should not be used.

Special Materials

- *Do not* use materials that are sensitive to heat (such as thermal papers)
- *Do not* use materials that are sensitive to minor magnetic fields
- *Do not* use pressure-sensitive materials



This page is intentionally blank.





Declaration of Conformity

This (these) product(s) FPi 5100/6100/7100/8100 Series are identical in construction to the product(s) with the type designation Relay™ 5000/6000/7000/8000 Series.

The Declaration of Conformity of the original manufacturer shown on the following page is therefore fully applicable to the product(s) described here.

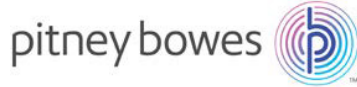

DECLARATION OF CONFORMITY (En)
DÉCLARATION DE CONFORMITÉ (Fr)
KONFORMITÄTSERKLÄRUNG (De)
DICHIARAZIONE DI CONFORMITÀ (It)
FÖRSÄKRAN OM ÖVERENSSTÄMMELSE (Sw)
SAMSVARSERKLÆRING (Nor)

U.S.A.

Pitney Bowes, Inc.
 3001 Summer street
 Stamford, CT 06926
 U.S.A.

UK

Pitney Bowes Limited
 Building 5, Trident Place
 Hatfield Business Park
 Mosquito Way
 Hatfield, Hertfordshire AL10 9UJ
 United Kingdom
 Tel: 44-(0)333-999-4000
www.pitneybowes.co.uk

EU

Pitney Bowes Deutschland GmbH
 Poststr. 4-6
 64293 Darmstadt
 Germany

declare under our sole responsibility / Déclarons sous notre seule responsabilité / erklären, in alleiniger Verantwortung / dichiariamo sotto nostra unica responsabilità / försäkrar under eget ansvar / erklærer under vårt eneansvar:

Product Type / Type de produit / Produkttyp / Tipo di prodotto / Produkttyp / Produkttype:
 Relay 5000™, Relay 6000™, Relay 7000™, Relay 8000™ Inserting System

Model / Modèle / Modell / Modello / Modell / Modell:
 F700, F70D, F70G, F70K

Options / Options / Zubehor / Opzioni / Tillval / Tilleggsutstyr:
 F70Y, F70U, F70T, F70EF, F7T4, F70V

complies with following EU Directives and Standards / est conforme aux directives et normes CE suivantes / entspricht den folgenden EU-Richtlinien und –Standards / e conforme alle seguenti direttive e standard CE / følger følgende EG-direktiv och standarder / er i samsvar med EU-direktivene og standardene nedenfor:

EMC / CEM/ EMV / CEM / EMC / EMC 2014/30/EC	EN 55032:2012 (Class A) EN 61000-3-2:2014 EN 61000-3-3:2013 EN 55024:2010
Low Voltage / Sécurité / Sicherheit / Sicurezza / Säkerhet / Sikkerhet 2014/35/EC	EN 62368-1:2014 + A11:2017 EN 60950-1:2006 + A11:2009 + A1: 2010 + A12:2011 + A2:2013
RoHS 2011/65/EU	EN 50581:2012

 12-1-2020
 Mark Scribe: Director HW Product Development
 Pitney Bowes, Inc.
 27 Waterview Drive
 Shelton, CT 06848 U.S.A.



Francotyp-Postalia GmbH
Prenzlauer Promenade 28 · 13089 Berlin (Germany)
Freecall: +49 800 372 62 68
info@francotyp.com · [fp-francotyp.com](https://www.fp-francotyp.com)

